

Operating Manual

for

BiO.Li.X!

Storage

Range

FAB

Version: 1.1

Important Notice

© 2021, 2022, 2024 LiCONiC AG Liechtenstein, all rights reserved.

The Information contained in this document is subject to change without notice.

Information provided by LiCONiC AG is believed to be accurate and reliable. However, the user is responsible for the proper and correct use of the product. No license is granted by acquisition of the product for any patent or patent rights of LiCONiC. If the user does not follow the instructions given in this manual, LiCONiC does not take any responsibility for injuries or damages caused by the LiCONiC product.

Contact Address

LiCONiC AG
Industriestrasse 8-12
FL - 9493 Mauren
Principality of Liechtenstein

Telephone: +423 340 50 00
Telex: +423 373 53 59
E-mail: info@liconic.com
Internet: www.liconic.com

Before operating the instrument, the user must read and understand this manual.

Installation and Servicing

Installation, servicing and reinstallation of the instrument shall only be performed by System Integrators and / or service personnel authorized by LiCONiC AG.

LiCONiC regularly offers Operator Training Courses. We highly recommend the attendance of such a course prior to working with a LiCONiC Instrument.

History Page

Document Change History

<i>Date</i>	<i>Version</i>	<i>Changes</i>	<i>Author</i>
23.11.2022	1.0	Initial Realease of updated Manual	Ralf Kindle
04.06.2024	1.1	Add Dry ice hazard warning	Ralf Kindle

Table of Contents

Contents

1.	About the Product and its Manual	7
1.1	Intended Use	7
1.2	Unintended Use	7
1.3	Product Identification.....	7
1.4	Scope of Delivery.....	7
1.5	General.....	8
1.6	Definitions	8
1.7	Target User Group	8
1.8	Importance of the Safety Instructions	8
1.9	Labels	9
1.10	Safety - Basics.....	9
1.10.1	General Operating Hazards	9
1.10.2	Mechanical Hazards	9
1.10.3	Electrical Hazards.....	9
1.10.4	Chemical, Biological and Radioactive Hazards.....	9
1.10.5	Extreme Temperature Hazards	10
1.10.6	Suffocation Hazard	10
1.11	General Safety Regulations	11
1.11.1	Legal Requirements.....	11
1.11.2	General Inspection and Maintenance Duties	11
1.11.3	Spare Parts to be used	11
1.11.4	Modifications	11
2.	Biolix FAB Stores	12
2.1	FAB Store	12
2.1.1	Store	12
2.1.2	Features	13
2.1.3	Configuration Overview.....	16
3.	Climate	17
3.1	Overview.....	17
3.2	Cooling.....	17
3.3	Temperature	17
3.4	Humidity.....	18
4.	Tube Handling.....	19
4.1	General.....	19
4.2	Options	20
4.2.1	HD-Rack capability	20
4.2.2	Revolving Head Option	20
4.2.3	Side Code Reader with Rotating Endeffector	21
4.2.4	Multi Nest Tube Handling.....	21
4.2.5	Custom Tube Handlings	21
5.	Identification	22
5.1	Barcode reader	22
5.1.1	Supported Barcode Types	22
5.1.2	Barcode Specifications	22
5.2	Falcon Eye FE2D-138 scanner	23
5.2.1	Supported 2D code Types	23
5.2.2	2D code scanner Specifications	23
6.	Biolix FAB Store Cassettes.....	24

7.	Gassing Installation	26
7.1	Kiwi Store Gassing and Backup Options	26
7.1.1	Safety Information	26
7.1.2	Installation Safety Recommendations	29
7.1.3	Backup Refrigeration installation	32
7.1.4	Specific Advice for LN2 Liquid Nitrogen	33
7.1.5	Refill LN2 Liquid Nitrogen cylinder	35
8.	Alert System	36
8.1	FAB Alerts	36
8.2	Interface Alerts	36
8.3	Tube Handling Alerts	36
9.	Barcode Reader	37
9.1	1D Reader for racks and plates	37
9.2	2D Rack Scanner / Reader	37
10.	Cassettes	38
10.1	Interface Cassettes	38
10.2	41	
10.3	FAB Store Cassettes	42
11.	Power-On Interface	45
12.	Power-On FAB Store	46
13.	Cooling unit operation	46
13.1	Switch on cooling STC ULT	46
13.2	Recovery after Backup activation	48
13.2.1	Procedure	48
13.3	Service operation of backup cooling	49
13.3.1	Procedure	49
14.	Climate Settings	50
14.1	Temperature Settings	50
14.2	Humidity Settings	50
15.	Routine Safety Checks	51
16.	Sample Management Software	52
16.1	Order File	52
16.1.1	Simple order file	52
16.1.2	Complex order file	53
16.2	Import – Export Interface	54
16.2.1	Import	54
16.2.2	Export	60
16.2.3	Exception Plates	63
16.2.4	Connections	64
16.3	PlateExplorer	64
16.3.1	General Functionalities	65
16.3.2	Layout of the PlateExplorer	66
16.3.3	User Management and Alarm Notification	73
16.3.4	Partitions Tool	75
16.3.5	Right-Click Action Menus in the Tree View	81
16.3.6	History	88
16.3.7	Right-Click Menu on Tubes at Tube Handling	90
16.3.8	Right-Click Action Menu on 2D Rack Reader	91
16.4	Job Manager	94
16.4.1	Use of JobManager	94
16.5	Climate Reporting	97

17. Utility Tools	100
17.1 Web Terminal.....	100
18. Technical Data	101
18.1 Mechanics.....	101
18.2 Electronics	101
18.2.1 Robotics	101
18.2.2 Cooling.....	101
18.2.3 Communication.....	101
18.3 Pneumatics	101
18.4 Water	101
18.5 Cooling.....	102
18.5.1 DF	102
18.5.2 ULT	102
18.6 Overall Dimensions.....	102
18.7 Weights.....	102
18.8 Ambient Ratings.....	102

Introduction

1. About the Product and its Manual

1.1 Intended Use

The LiCONiC BiOLiX! Store is intended for storage, identification and transfer of Microplates and Tubes. It is to be applied exclusively in the research field. The LiCONiC BiOLiX! Store is intended to work as a stand-alone unit or an element in an automated system.

1.2 Unintended Use

Due to its open architecture, the LiCONiC BiOLiX! Store is NOT intended for regulated clinical and diagnostic applications (IvD Directive).

Read the safety instructions in this Manual carefully.

1.3 Product Identification

The Type Plate is located the power cabinet of the LiCONiC FAB

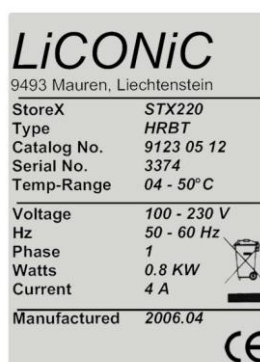

For future reference, please read the instrument Serial No. on the Label located in the power cabinet of your instrument and write it in the provided space.

1.4 Scope of Delivery

- Basic Unit, consisting of a Cassette Lift, an ante chamber and the storage chamber
- Cooling unit for storage chamber
- Cooling unit for ante chamber
- Interface Unit, consisting of a Handling, the Tube Handling and transfer location to storage
- Product Documents
- Cables
- User Software and Drivers
- Cassettes (as specified)
- Redundant Cooling (only if ordered)
- LN2 Backup (only if ordered, does not include DEWAR)

Exact delivery scope may differ according to project scope

1.5 General

The LiCONiC BiOLiX! Store is a complete product for end users. Setup of equipment is conducted by LiCONiC Engineers or by LiCONiC trained and certified personnel.

1.6 Definitions

Operator:	Any person who uses the equipment for its intended purpose.
System Integrator:	Authorized person or company responsible for integration, installation, initial startup and overall safety of the system.
Authorized Engineer	Authorized person responsible for installation, initial startup. Person who carries out service and maintenance tasks and is therefore contacted in the case of any problems with the system.
Plate	Any lab ware according to SBS standard, such as MTP (micro titer plate), NTP (nano titer plate), DWP (deep well plate), tube racks and other carriers.

1.7 Target User Group

The Kiwi Store has been conceived for applications in the research field.

Instrument operation requires a trained user.

1.8 Importance of the Safety Instructions

This chapter contains general information assuring safe operation of the instrument. More specific instructions in regard to safety are given throughout this manual, at the respective points where observation is most important.

Make sure that all Safety Instructions in this publication are strictly followed.

1.9 Labels

Throughout this publication, Warning Notices are to be interpreted as follows:



WARNING!

Indicates the possibility of severe personal injury, loss of life or equipment damage if instructions are not followed.



CAUTION!

Indicates the possibility of severe equipment damage if instructions are not followed.



NOTE!

Gives helpful information about the equipment.



DANGER!

May be harmful to your eyes.

1.10 Safety - Basics

1.10.1 General Operating Hazards

Carefully observe the following precautions:

1.10.2 Mechanical Hazards

Keep the housing and safety panels closed and never reach into the instrument work space when the unit is in operating mode. Ensure safety of user prior to any tasks sent to the equipment.

1.10.3 Electrical Hazards

Keep the housing and safety panels closed. Before opening any of the panels disconnect the power supply to avoid electrical shock.

1.10.4 Chemical, Biological and Radioactive Hazards

All samples and test-kit components must be considered as potentially hazardous agents. Therefore, a potential risk may arise from the liquids being handled, such as infectious biological samples, toxic or corrosive chemicals, or radioactive substances. Strictly apply appropriate safety precautions according to local, state and federal regulations.

Prior to any first time application, test runs should be made with a neutral liquid to allow optimization of all liquid handling parameters.

Handling and disposing of waste has to be in accordance with all local, state and federal environmental, health and safety laws and regulations.

Prior to executing any maintenance task on the instrument or sending it, or parts of it for repair, the instrument or the parts have to be thoroughly decontaminated.

1.10.5 Extreme Temperature Hazards

All surfaces inside the storage chambers, interface and some parts of the refrigeration may be considered as potentially dangerous if touched without sufficient protective clothing. All components externally to the chamber are protected and are not able to be touched. Only if protective covers are removed components with extreme cold or heat may be touchable.

Inside the chamber temperatures below zero degree Celsius are present. Contact to any surfaces with bear skin should be avoided. Protective clothing has to be worn when manual operations are performed inside the chamber.

1.10.6 Suffocation Hazard

When entering the ante chamber and service area of the Storage chamber a potential risk of suffocation is present. A maximum of 15 minutes is given to stay in them without a respirator. When entering a O2 monitor has to be worn under any circumstances. The monitor has to provide at least an adjustable O2 low limit and an acoustic alert when O2 level is too low.



WARNING !	
➤	Inert gases are asphyxiating and will displace oxygen to produce localized oxygen deficient atmospheres
➤	Inert gases are odorless, colorless and tasteless
➤	Inert gases give no warning and may cause death in few seconds
➤	The Exhaust of the CO2 or LN2 backup cooling option needs to be led out of the building otherwise danger of suffocation is immanent
➤	In their liquid state inert gases are extremely cold fluids which can cause serious burns when in contact with the skin
➤	A cryogenic spill often gives a low-lying cloud of vapor that creeps along the ground
➤	Due to very specific local rules and regulations in different countries it is the customers / owner's responsibility to install suitable oxygen (O2) and carbon dioxide (CO2) monitor systems which trigger alarms to protect operators in and around the FAB store.
➤	Dry ice (solid CO2) has never to be stored in the Ante Chamber or Service Area due to concentration increase in CO2. CO2/O2 monitoring is mandatory when dry ice is used for sample transport.

It is not allowed to work inside the system alone. A second person has to be outside surveying the work inside and to be in permanent contact with a radio with the person inside.

1.11 General Safety Regulations

1.11.1 Legal Requirements

Please consult the Manufacturer's Declaration, delivered with each unit by LiCONiC AG, listing all applied directives and standards.

In Europe, the System Integrator must provide a Conformity Declaration upon final installation of the entire system.

1.11.2 General Inspection and Maintenance Duties

Only an authorized Engineer shall carry out inspection, maintenance and repair tasks.

1.11.3 Spare Parts to be used

Only original LiCONiC Spare Parts may be used. If other parts are used during the normal warranty period, the manufacturer's guarantee may be invalidated.

1.11.4 Modifications

Modifications shall only be carried out by an authorized Engineer. LiCONiC AG will not accept responsibility for any claim resulting from unauthorized modification or alteration.

General

2. Biolix FAB Stores

2.1 FAB Store

2.1.1 Store

The Biolix FAB Store is the most compact storage with integrated cassette handling that covers fully-automated plate storage needs at -20°C and -80°C . The Biolix FAB Series offers dry climate storage.

The modular mechanical design in combination with extremely simple commands eases the use of these systems in any environment. A growing number of accessories are available for this series.



2.1.2 Features

All Biolix FAB Stores have compact dimensions. It has a user front door which allows comfortable and easy access to the ante chamber. The ante chamber is the operation space for the transfer of racks and plates from any additional equipment or transport box into the actual interface unit. Exchangeable cassettes make the use of the Biolix FAB Store extremely flexible. Cassettes are available for all common plate types.

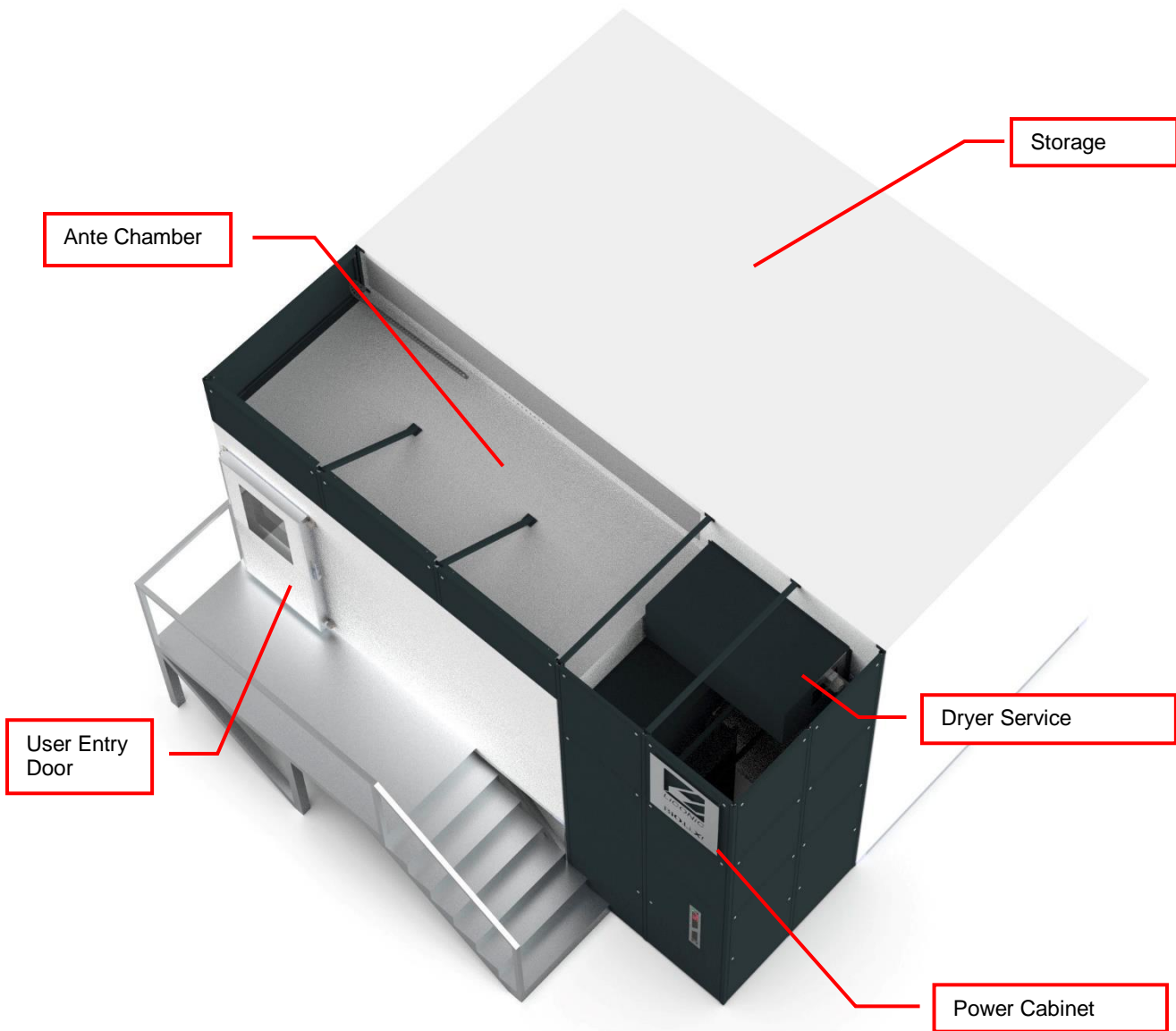

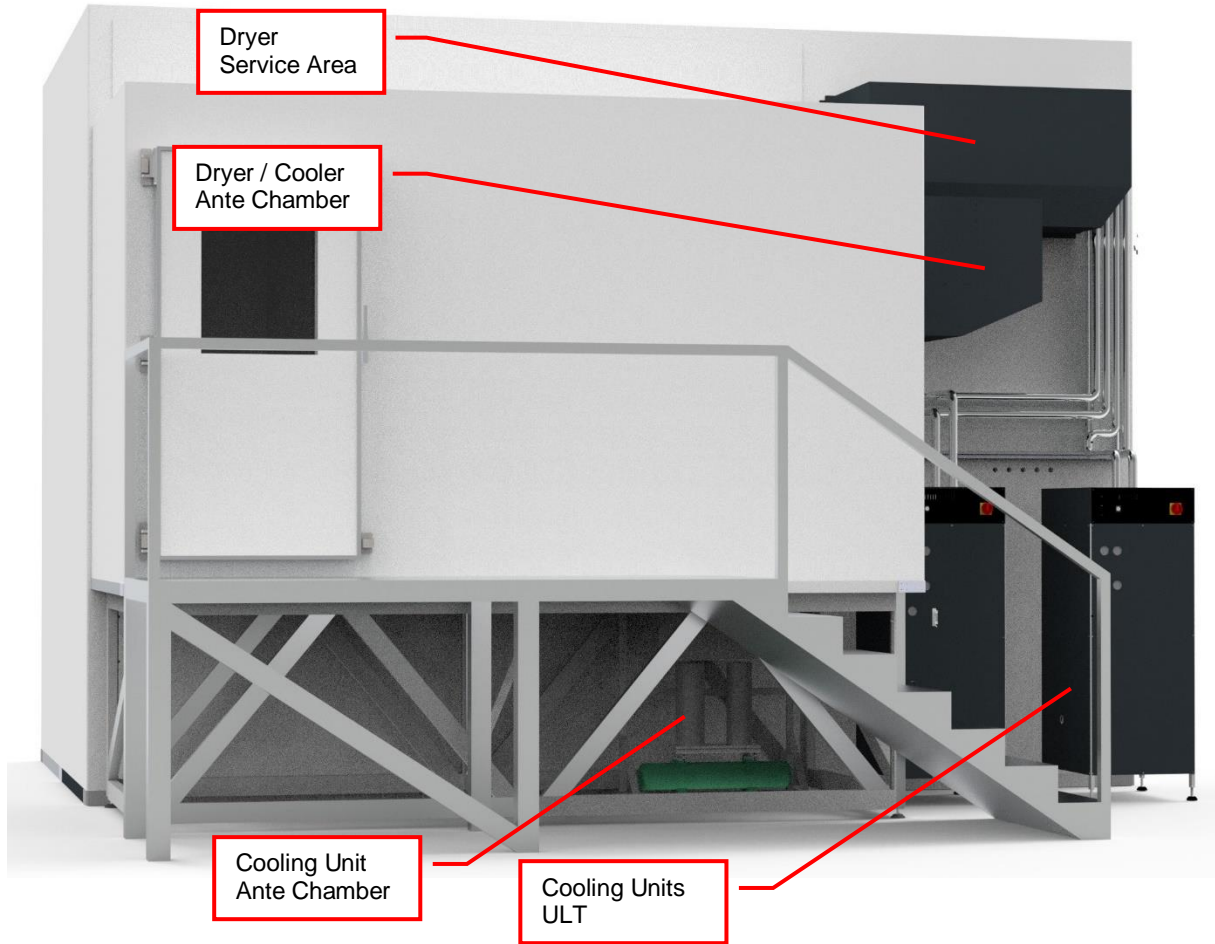

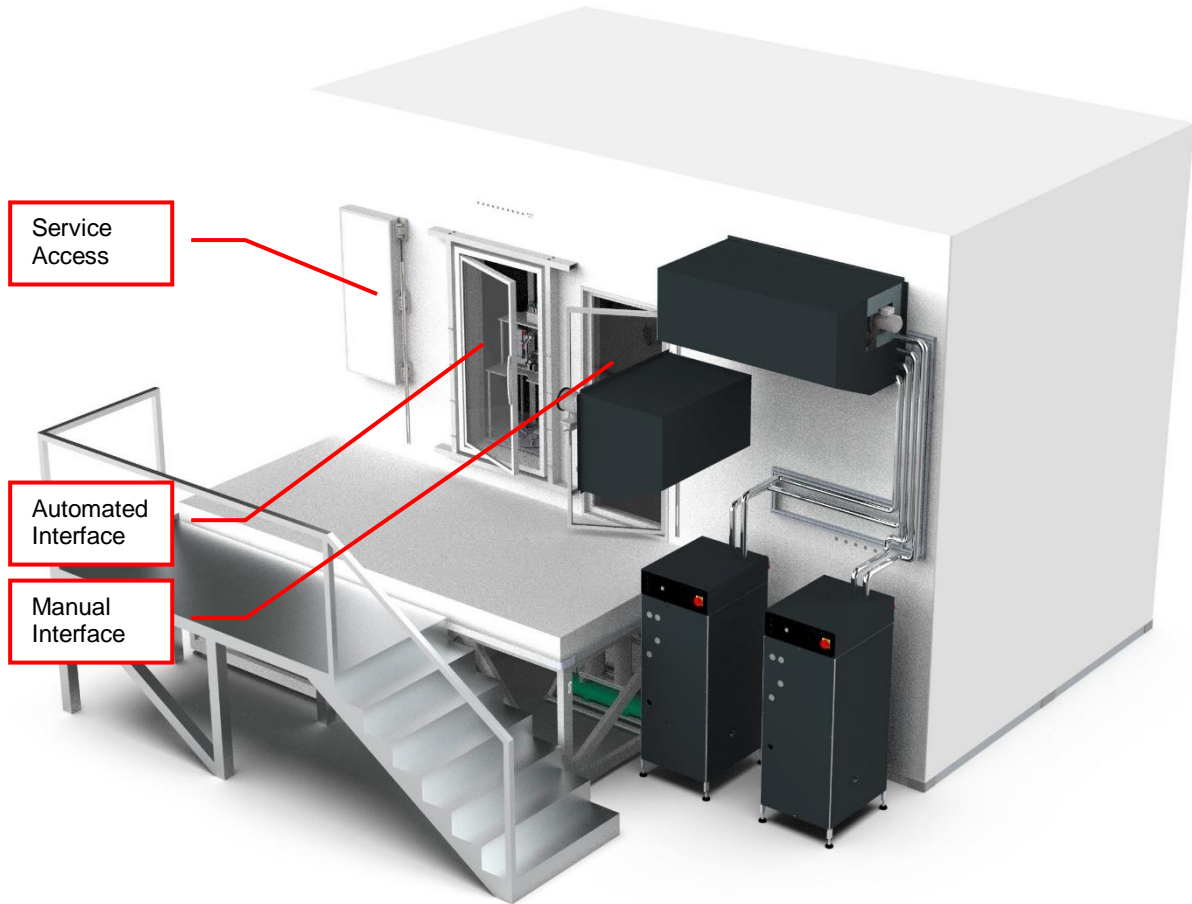

2.1.3 Configuration Overview

The Systems are structured by their capacity in Microtiter plates (MTP) and their climate.

The Biolix FAB Storages are Stand Alone System for fully-automated operation.

For detailed systems dimensions please contact LiCONiC AG. These Systems are built to specification and specific system dimensions may vary according to system configuration.

Further Storage sizes are available on request. All Biolix Stores can handle and store a wide range of types of plates and racks with SBS standard format. The corresponding capacity is only depending of the height of the racks. Special formats such as cryo boxes and larger sizes are available upon request.

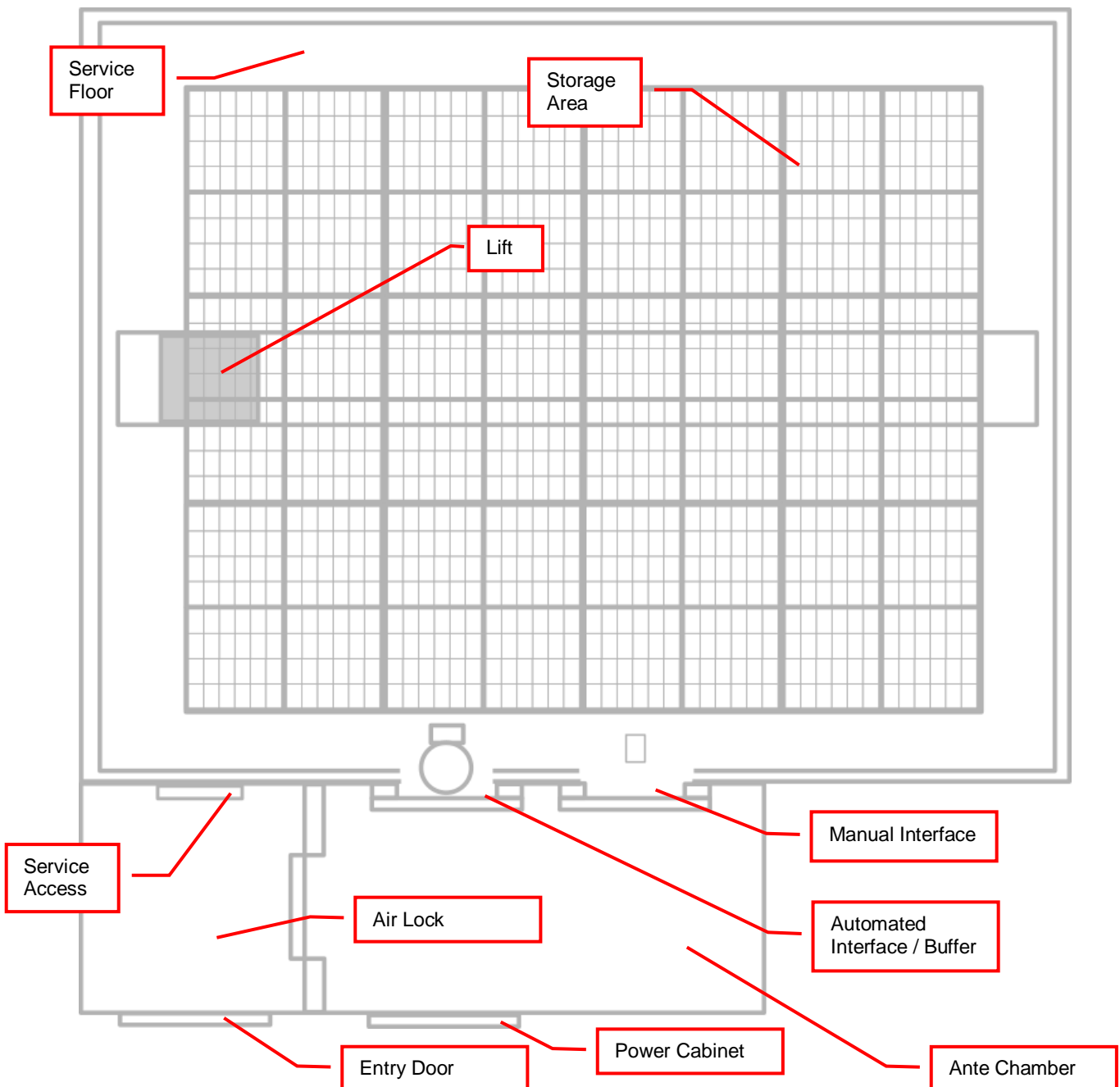

Options

3. Climate

3.1 Overview

Name	Temperature	Humidity
DF Deep Freezer	-20..00°C	02..45%RH
ULT Ultra Low Temperature	-80°C	n.a.

The DF Stores are designated for the use as compound storage, whereas the ULT version is mainly for Biobanking use.

3.2 Cooling

Within all units the air is actively dried by forcing the air through an evaporator. This allows cooling and actively drying the air. Since the evaporator gets covered with ice after a certain time a defrost cycle has to be run. During the defrost the air circulation is stopped and resumed as soon the defrost has ended. The collected water will be exhausted through a drain.

In the ULT storage are only passive convection for maintaining the temperature is present. No defrost is needed in the ULT zone as the moisture is captured in the interface and the service area of the system.

3.3 Temperature

All units are equipped with a Temperature-Sensor. This allows to displaying and to regulate the temperature inside the storage chamber. A very high-quality sensor is used for this purpose. Quality and accuracy of the sensor is maintained by the Swiss Federal Office of Metrology and the Swiss Accreditation Service (see specification in next chapter).

Due to the limited temperature range this sensor is used in the ULT storage systems to monitor and control the climate in the service area. To monitor all other temperature, such as parameters of cooling and storage chamber temperature, thermocouples are used.

3.4 Humidity

All units are equipped with an RH-Sensor. This allows displaying the humidity inside the storage chamber. A very high-quality sensor is used for this purpose. Quality and accuracy of the sensor is maintained by the Swiss Federal Office of Metrology and the Swiss Accreditation Service.

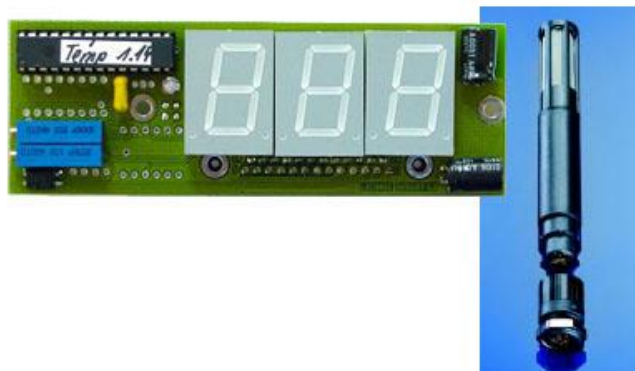

The Humidity sensors used in the systems are suitable for extremely high humidity as well as for extreme dryness. They incorporate a humidity and a temperature sensor allowing a relative humidity (RH) readout.

Specifications

Measuring Range	0..100	% RH
Accuracy@23°C	±1.5 ±0.1	% RH °C Temp.
Resolution	12 12	Bit / 0.02% Bit / 0.1°C
Sensor	RS485 HMP110	Temperature Humidity
Adjustment	-	E2-PROM

4. Tube Handling

4.1 General

The Kiwi units are distinguished through the capability to hold a tube handling unit under climatized conditions. The tube Handling is able to handle most tube types. The tube handling is integrated into the Liconic System and allows it to work under control climate conditions.

To work with the tube handling, rack need to be moved by the storage handling to the picker location and be placed into the source and target nest. The picker will pick up a Tube from the source and then places the tubes into the target.

There are tube handlings available which are compatible with following rack size: 24, 48, 60, 96, 138, 384. By default, the tube handling is configured to work with one tube format, such as 96 (138). The limitation is the endeffector which is moving the tube. This endeffector is only capable to handle a certain diameter range, hence different endeffectors for 24, 48, 96 and 384 are required. The handling can be equipped with an option which allows to handle up to two formats.

The handling is by default equipped with a rack retainer and a tube lifter. The lifter pushes up the tube for the endeffector to be taken. Hence for the source position the retainer is required to ensure the rack is not moved in any case.

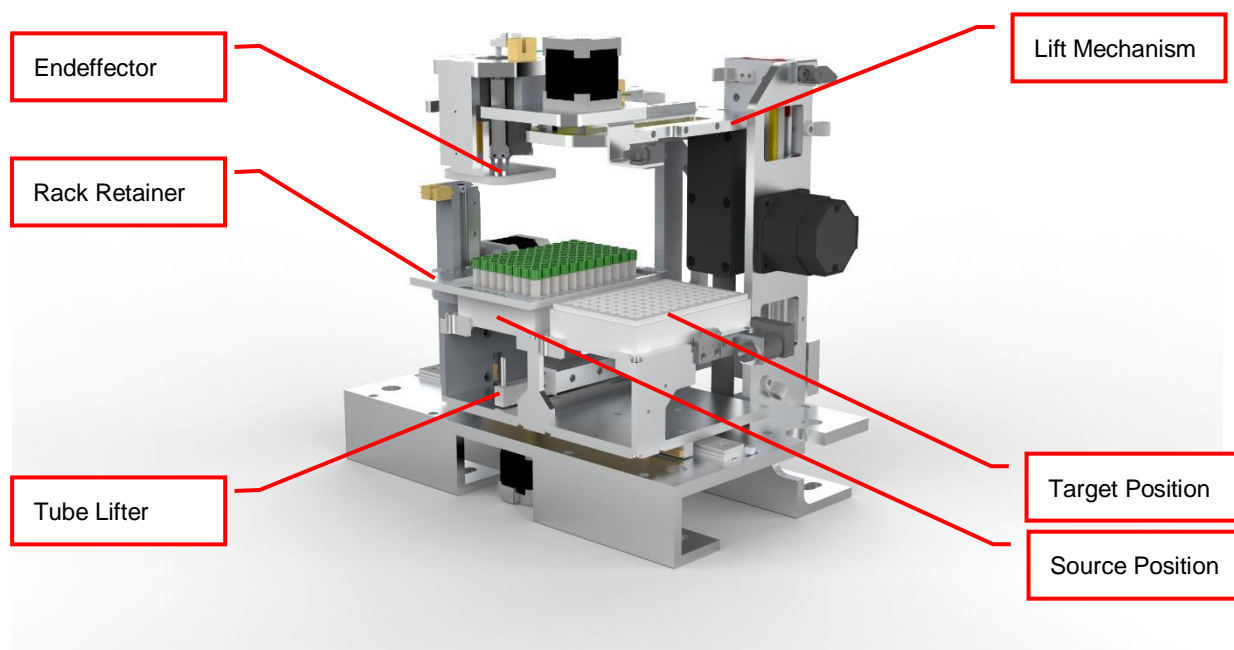

Solutions for push through labware are available upon request.

4.2 Options

4.2.1 HD-Rack capability

The latest generation of tube handlings are capable to work with HD Rack formats. It is possible to reformat from standard to HD format and back. Following two formats are commonly used:

Standard Format	HD Format
SBS 96	SBS 138
SBS 48	SBS 60

The use of HD formats on existing devices is possible but should be confirmed with a Liconic representative. Software configuration changes and teaching is required in any case.

4.2.2 Revolving Head Option

This option allows the tube handling to hold two endeffectors for different tube formats. Most commonly 48 and 96 are combined. Not all combinations are possible. For further information about possible combinations contact Liconic.

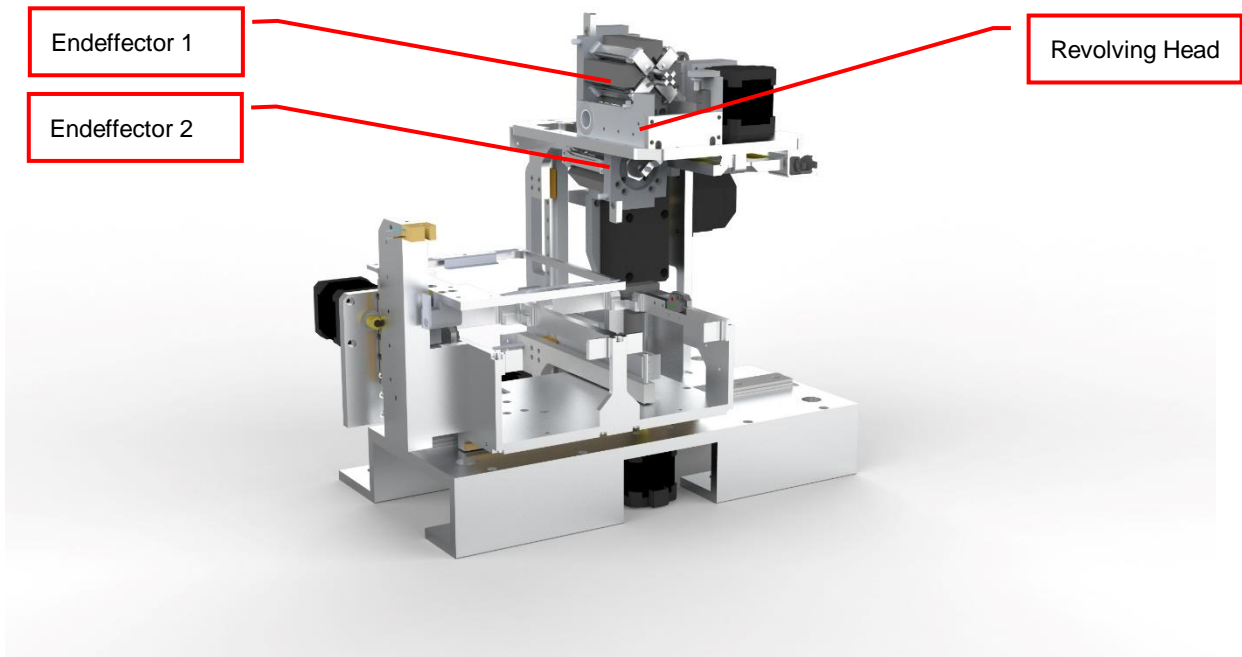

4.2.3 Side Code Reader with Rotating Endeffector

For tubes with side labels a solution is offered to read such labels. The reader is located at the side of the actual picking area. Each tube needs to be lifted up individually to be read. The reader is capable to identify 1D Barcodes and 2D Codes. As the position of the code may be initially not visible for the reader a rotating head is part of this option. The endeffector can be rotated nearly 360 degree in order to read the code at any location on the circumference of the tube body.

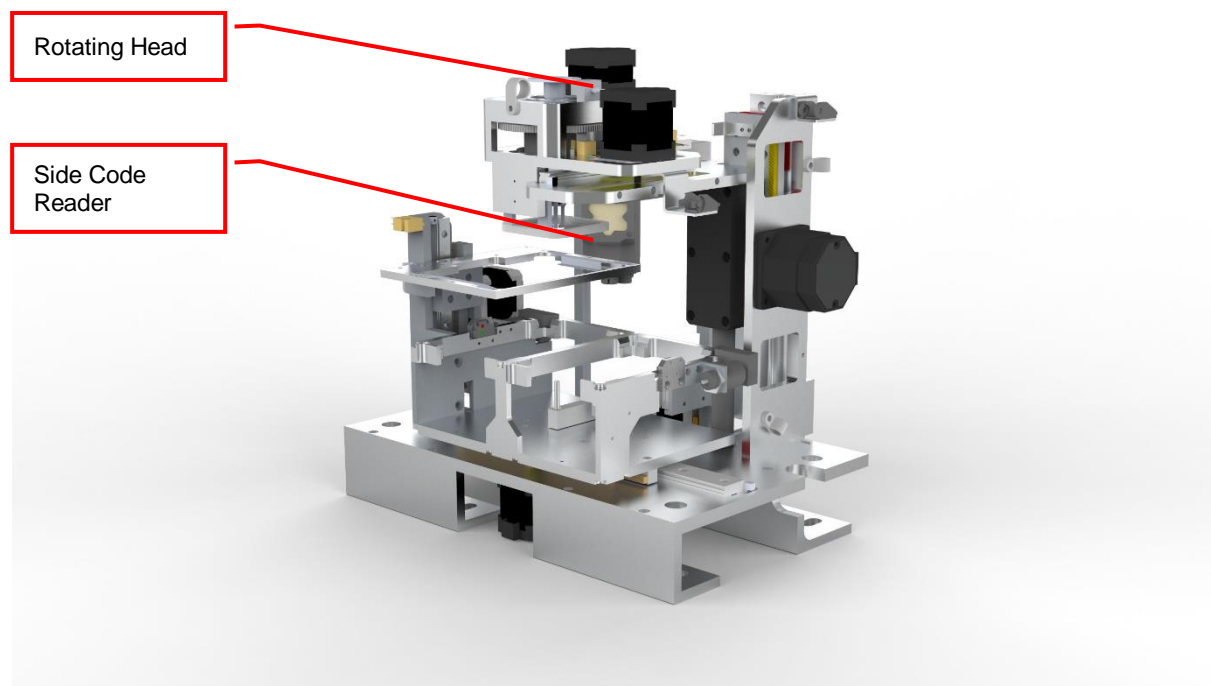

4.2.4 Multi Nest Tube Handling

Tube handlings can be offered with multiple source or target nest configurations, most suitable for the application. These solutions mainly are used when time constraints are a concern.

4.2.5 Custom Tube Handlings

For specific application custom solutions may be offered. These custom solutions will build on the mentioned features or a combination of them. Please contact Liconic for further information.

5. Identification

5.1 Barcode reader

A Bar Code Reader is installed on the Lift Assembly. It allows the reading of Bar Codes on plates stored in the cassettes. Bar Codes have to be printed on the shorter side of the plates and have to face outwards to the Lift Assembly.



5.1.1 Supported Barcode Types

The barcode reader recognizes the following barcode types.

- Code 128 number of characters : 1..32
- Code 39 number of characters : 3..32
- Coda bar number of characters : 3..32
- EAN(UPC (A/E) EAN 13, EAN 8, UPC-E
- ITF
- Industrial 2 of 5
- COOP 2of5
- Code 93
- EAN-128

5.1.2 Barcode Specifications

- Light Source: Semiconductor Laser
- Wavelength: 650nm
- Output: 1.0mW
- Class: FDA: Class II
IEC 825-1 11.1993: Class 2
DIN EN 608251 07.1994: Klasse 2
- Reading Bar Width: Reading Bar Width: 0.125 – 1.0 mm
0.15 – 1.0 mm for Code 93 and Code 128
- Ambient Light: Sunlight 10'000 lx
- Incandescent Lamp: 6'000 lx
- UL Applicable standards
- UL File No.
- UL category

5.2 Falcon Eye FE2D-138 scanner

A 2D code whole rack scanner can be integrated into the systems. It allows the reading of 2D Codes of a whole rack at once under controlled climate condition. To read the 2D codes, the rack needs moved as a whole to the reader.

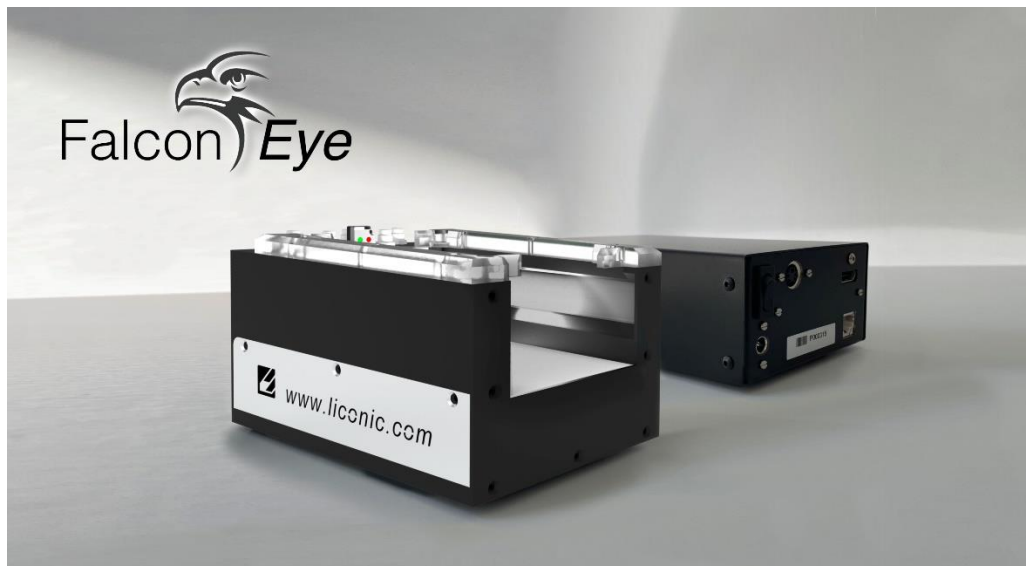

5.2.1 Supported 2D code Types

The optional 2D code reader recognizes the following 2D code types.

- DataMatrix

5.2.2 2D code scanner Specifications

- Scanning Device: Customized camera-based scanner
- Compatible rack vendors
 - Thermo Matrix
 - Thermo Abgene
 - Thermo Nunc
 - Remp
 - Micronic
 - FluidX
 - HD Racks
 - Further types possible
- Compatible rack sizes: 24, 48, 96, 138, 240, 384
- Export data to Excel, text, XML, JSON, rack images
- Database connectivity: SQL Server, Oracle, MySQL, Postgres, HSQL and others [v1.23+]
- Operating system: Windows 7, 8 and 10
- Fast Scanning — 2-3 seconds per rack
- Displays damaged/missing tubes
- One-click scan for any size or brand of tube
- Simple installer — no dongles required
- Multiple scanners/multiple configurations
- 100-240VAC automatically selected
- Fully integratable into robotics platforms

Accessories

6. Biolix FAB Store Cassettes

The buffer unit includes five buffer cassettes which are 505 mm in height.

The store cassette capacity is depending on its usable cassette height given by the cassettes Series.

The System Capacity depends on the specific configuration.

The Kiwi Store can handle almost every plate or tube racks in SBS format currently available on the market. For optimum performance LiCONiC offers a variety of cassettes.



Store Cassette
Example

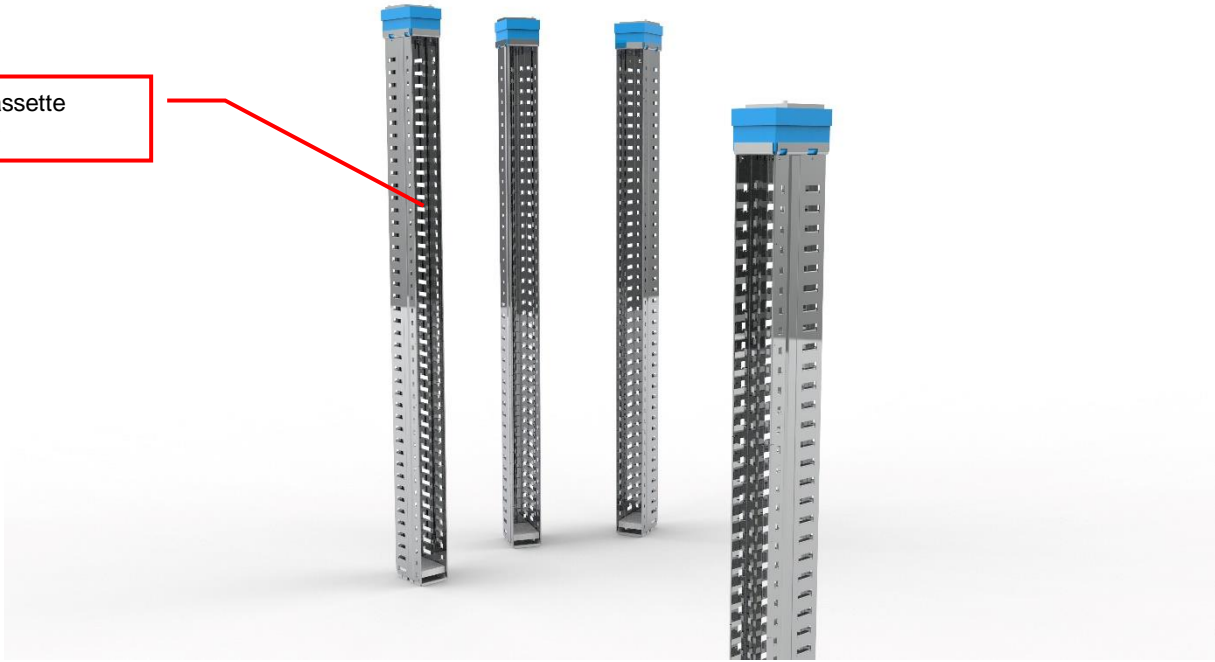

Installations

7. Gassing Installation

7.1 Kiwi Store Gassing and Backup Options

The Kiwi Store series supports a wide selection of gassing and backup options. Typical properties of some commonly used options are described next. There are other gassing options available. Note that each gassing and backup option is linked to specific risks and hazards. It is important to be fully informed about any specific application before installing the instrument or even running any application.

7.1.1 Safety Information

General

Commonly used in research medicine are inert gases like: Nitrogen, Argon, Helium and Carbon Dioxide. Inert gases are used mainly to create and maintain inert atmospheres for an application or process. The above gases, which generally don't react with other materials, displace oxygen in order to maintain an inert, contaminant free atmosphere.

In their liquid form these gases are very cold, (the boiling point of liquid nitrogen is -196°C). Such cold liquids are known as cryogenic liquids, (from the Greek, kryos meaning frost and gene meaning producing). The liquid gases therefore can be used as backup cooling option in case of power failure.

Major hazards

There are some major hazards associated with these gases



WARNING !

- Inert gases are asphyxiating and will displace oxygen to produce localized oxygen deficient atmospheres
- Inert gases are odorless, colorless and tasteless
- Inert gases give no warning and may cause death in few seconds

Oxygen is the only gas, which supports life. The normal concentration in the air that we breathe is approximately 21%. If the oxygen concentration in air diminishes or, (what amounts to the same) if the concentration of inert gases increases, a situation is rapidly reached where the hazards of asphyxia become very great.

The danger occurs as soon as the oxygen levels are lower than 16%. Inert gases are odorless, colorless and tasteless and are therefore a great deal more dangerous than other gases such as chlorine, ammonia, or hydrogen sulfide, which can be detected by their odor, at very low concentrations. The asphyxiating effect of inert gases occurs without any preceding physiological signals which could alert the victim. It takes place very rapidly: just a few dozen seconds with very low oxygen content. Stated clearly "you do not notice that you are passing out!"

The danger from the inert gases such as nitrogen, argon, helium, etc. cannot be stressed enough. Especially in this case of Asphyxia as there are no warning signs. People also vary considerably in their reactions to oxygen deficiency.

**WARNING !**

- In their liquid state inert gases are extremely cold fluids which can cause serious burns when in contact with the skin
- A cryogenic spill often gives a low-lying cloud of vapor that creeps along the ground

When a cryogenic liquid is released into the atmosphere, it evaporates and forms a dense cloud. As it is very cold it is heavy and hangs close to the ground. So, it will flow into any low-lying areas, such as drains or pits. Therefore, the first warning of a cryogenic spill is often given by the presence of a low-lying cloud of vapor that creeps along the ground. These clouds can be dangerous, as their temperature or composition will be unknown. Visibility within the cloud is very low with the possibility of falling, perhaps into contact with the cryogenic liquid. If the cloud is nitrogen or argon then it is very likely that the cloud does not contain sufficient oxygen to support life. In this case unconsciousness could be immediate and death could follow.

**CAUTION !**

- When you see a cryogenic spill or a large vapor cloud notify qualified personnel immediately
- Shut off the source of liquid, by a REMOTELY controlled valve
- Do not enter a vapor cloud caused by vaporizing cryogenic liquid
- DO NOT SMOKE!

When you see a cryogenic spill or a large vapor cloud notify qualified personnel immediately. Call the Fire Department in the case of a large liquid oxygen spill. Have them stand by until the spillage is dispersed.

If possible shut off the source of liquid, by a **remotely** controlled valve if one is fitted. Do not expose yourself to the hazard, such as high oxygen, combustible or asphyxiating atmospheres or cryogenic liquid. Do not allow liquid oxygen to enter drains or sewers. If so advised, shut down any air conditioning or ventilating systems that may draw vapor or gas from the spill into other locations.

If it is essential to enter a cloud caused by nitrogen or argon (note: never enter one that could be rich in oxygen), then wear a self-contained breathing apparatus provided you are trained and qualified to do so. A stand-by person, also wearing breathing apparatus must keep you under surveillance. If the release is oxygen, then your clothes could be saturated making them extremely flammable. If you suspect that you have been contaminated with oxygen do not go near any source of ignition for no less than 15 minutes. Ventilate your clothing; change if possible. A fire may occur at any time in the oxygen cloud, should it come into contact with highly combustible material.

General Safety Instructions

When working with inert gases prevent contact of liquid gas, cold vapors, or "snow" with exposed skin. Prevent entrapment of liquid in closed systems. Use only in well ventilated areas. Compressed gas cylinders contain gaseous and liquid gas at extremely high pressure and should be handled with care. Use a pressure-reducing regulator when connecting to lower pressure piping systems. Secure cylinders when in use. Never use direct flame to heat a compressed gas cylinder. Use a check valve to prevent backflow into a storage container. Avoid dragging, rolling, or sliding the cylinders, even for a short distance. Use a suitable hand truck. For additional handling recommendations on compressed gas cylinders, consult the Compressed Gas Association Pamphlet P-1.



CAUTION !

- Wear loose fitting gloves of impermeable material such as leather when working with cold liquid, solid, or vapor
- Safety glasses are recommended when handling high-pressure cylinders and in areas where vapors are discharged

Set-up gas cylinder in a well-ventilated area. Keep cylinder away from sources of heat. Storage should not be in heavy traffic areas to prevent accidental knocking over or damage from passing or falling objects. Valve caps should remain on cylinders not connected for use. Segregate full and empty cylinders. Storage areas should be free of combustible material. Avoid exposure to areas where salt or other corrosive chemicals are present. Install carbon dioxide cylinders with the valve end up. See Compressed Gas Association Pamphlet P-1 for additional recommendations.

7.1.2 Installation Safety Recommendations

Preventive Measures

The very first preventive measure is to inform all persons who handle or who use inert gases:

- Of the hazard represented by the refraction of oxygen in atmosphere
- Of the preventive means to be employed in handling the gases
- Of procedures to be observed should an accident occur

This information and training should be systematically and periodically reviewed in order to maintain an awareness with regard to these hazards. In particular, training in rescue work is fundamental since quickly improvised rescue, without the respect of a strict procedure, often proves to be ineffective, if not catastrophic (the rescue worker lacking foresight becomes a second victim). An annual program of training and rescue drills is recommended.

Ventilation

Depending on the existing ventilation, amount of gas used and size of room where the unit is installed and operated, ventilation may be required. A local exhaust may be useful at the point of sources of possible gas vapors. Where low lying areas are not naturally ventilated vents should be situated to avoid higher than normal concentration. Hazards to be considered in confined spaces are:

- Limited access and exits
- Increased likelihood of gas accumulation through leaks
- Increased asphyxiation risk
- Fire and explosion hazard

To be considered as confined spaces are the inside rooms of a building, laboratory rooms, machine pits, culverts, basement trenches for piping. When working in confined spaces, it is advisable that operators and other personnel are fully aware of the hazards of oxygen deficiency and adopt the following practices:

- A fully documented permit to work system
- Personal and fixed oxygen analyzers
- Self-contained breathing apparatus available for use and all personnel fully trained in its use
- Personnel harnesses and ropes
- Operation of the "buddy system"
- A system of fresh air ventilation and fume extraction

In the case of permanent presence of personnel in a room where there are risks of oxygen depletion mixture, ventilation must be maintained with at least 30mJ per hour per person. The volume of air introduced per hour must not be less than twice the enclosed space in question. Ventilation should never be carried out with pure oxygen, but solely with air.

Testing of Oxygen or Gas Content

At present, various types of oxygen analyzers are available, which are often simple and reliable to operate. Such a monitor should at least have

- A readout of the actual gas concentration
- A settable alarm threshold value
- An alarm output with an acoustic and optical alarm connected
- An error output that shows malfunction of the monitor

Ideally the monitor should be placed so that it can be read inside, as well as from outside, the room which has gas present. The selection of the type of apparatus depends on the nature of the work in the place to be monitored (temperature, multiple detectors, portable equipment, etc). The picture below shows such a monitor for CO₂.



Testing the oxygen content is desirable, although attention must be drawn to the fact that an analyzer alone is not absolute protection. Such equipment can always malfunction, unexpectedly be out of adjustment or detectors can be improperly positioned. Testing of oxygen content should therefore only be considered as an aid to the detection of a lack of oxygen.

Work Permit

For certain types of work, safety instructions and a special work procedure must be set up in the form of a work permit

Personnel Protection

Depending on the type of work to be performed, and the layout of the premises, the decision to provide additional protection for personnel may be taken on the initiative of the person in charge. Such additional protection may involve:

- The use of notices warning against the presence of a hazard
- The placing of a person on watch outside the work area
- The use of personal atmosphere monitors
- The organization of an alarm system for rapid intervention in case of an emergency
- The wearing of a harness so that the worker can be easily and rapidly taken out of an enclosed space in the case of an emergency. Preferably this harness is connected to a hoist to facilitate removing the victim. It is very difficult for one man to lift up another in the absence of a hoist.
- The wearing of an autonomous breathing mask, to the exclusion of all cartridge masks, which are ineffective in a case of lack of oxygen.
- The wearing of protective goggles and gloves when handling liquid nitrogen to avoid burns
- The wearing of all other means of protection, such as safety shoes, helmet, etc., depending on the circumstances

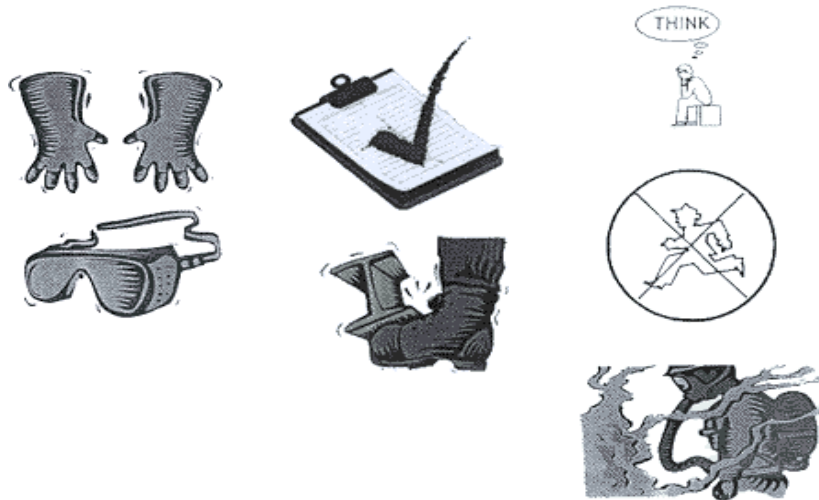

Considering the hazards mentioned above, it is essential to provide all those who handle or use inert gases with all the information and training necessary regarding safety instructions, means of prevention and procedures to be followed to avoid accidents, as well as rescue procedures to be implemented in the event of an accident.

7.1.3 Backup Refrigeration installation

On installations preferably choose pressurized liquid gas storage cylinders rather than wall outlets. The use of cylinders will limit the amount of gas being spilled in case of fatal failure. Whenever a wall outlet installation is chosen, make sure that there is a remote shut off valve installed outside the room where the liquid is used.

Place the cylinder in an easily accessible and visible place next to the system. Remember that the cylinder will have to be replaced or refilled routinely. As the operator will have to check the cylinder routinely it should be clearly visible to all personnel during routine work.

The room should provide a glass door or a window that will allow a good view of the instrument and gas connection from outside the room. Often major defects can easily be detected by visible vapor clouds or icy tubes without the risk of entering a contaminated room. If this is not possible a oxygen level meter with a remote alarm needs to be installed creating a acoustic and optical alarm in case of low oxygen level.

Before installation make sure that the maximum specified inlet pressure is never exceeded. Always install a main shut-off valve that will cut gas flow as close to the source as possible. Secure cylinder when in use.



WARNING!

- Never operate a damaged liquid gas cylinder
- Special pressure-reducing regulator may be required to operate a liquid gas backup.
- Never exceed maximum specified cylinder pressure
- Always ensure tight fit of all connections.

Supplied connection for liquid gas backup is a 1/2" SAE male (outside thread). For liquid gas cylinder such as Cryogenic cylinders, standard connection hose are available.

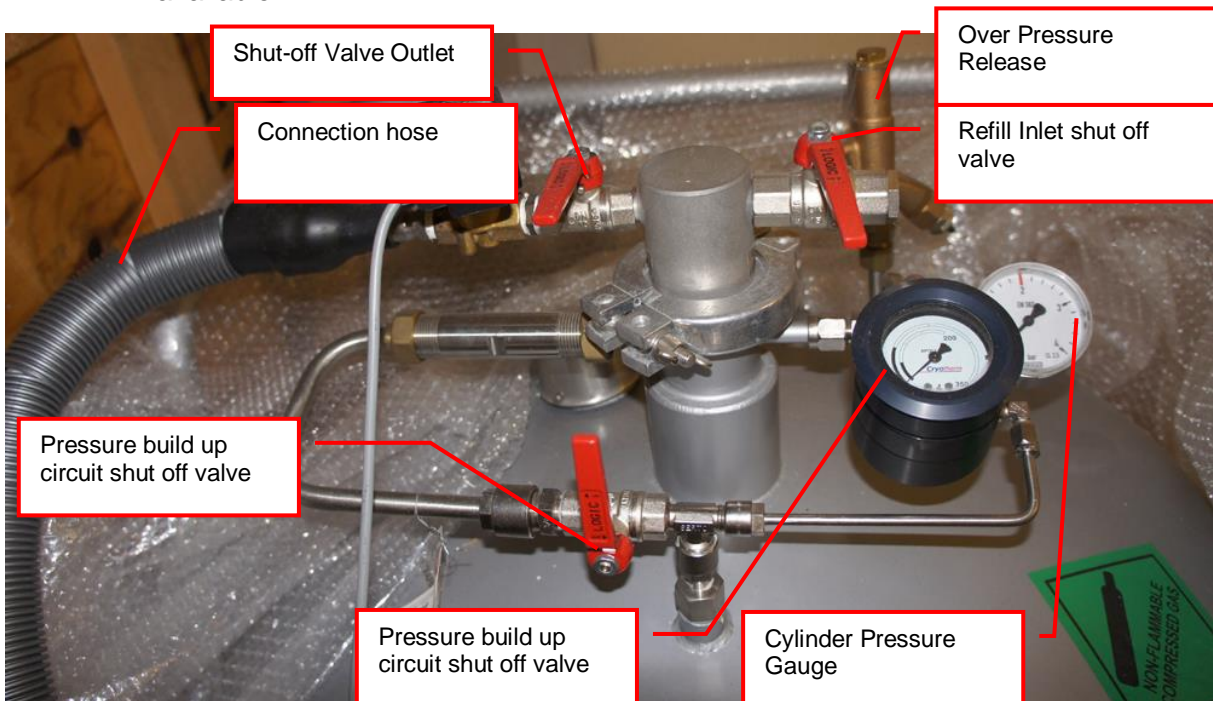

7.1.4 Specific Advice for LN2 Liquid Nitrogen

Properties of Nitrogen

Nitrogen is colorless, odorless and tasteless, as gas or liquid. It is nontoxic and non-flammable at atmospheric temperatures and pressures. A specific gravity of 0.9669 makes nitrogen slightly lighter than air. Nitrogen is mainly found in the atmosphere, where it accounts for 78.1% by volume of the air we breathe. It is stored in containers under its own vapor pressure.

Boiling Point @ 1 atm	-195.8°C (-320.4°F)
Freezing Point @ 1 atm	-209.9°C (-345.8°F)
Vapor Pressure @ 20°C	150 atm
Solubility in Water @ 0°C, 1 atm	2.3% vol.
Specific Gravity (air =1) @ 20°C, 1 atm	0.97

Health Hazard Data of Nitrogen

Nitrogen is inert and does not sustain life. Nitrogen is nontoxic, but may cause suffocation by displacing the oxygen in air.

Oxygen Concentration	Symptoms
21 - 14% (<19.5%) Oxygen	Increasing pulse rate, tiredness, dizziness, drowsiness, excess salivation, diminished mental alertness
14 - 11% Oxygen	Muscular coordination slightly disturbed, intellectual performance becomes difficult, breathing and pulse rate increased
11 – 8% Oxygen	Possibility of headaches, nausea and vomiting, collapse or loss of consciousness.
< 6% Oxygen:	Unconsciousness occurs without warning and so quickly that the individuals cannot help or protect themselves. Convulsive movements, possible respiratory collapse and death or brain damage

Spills of liquid Nitrogen have extremely cold temperatures of -196°C (-320°F) at atmospheric pressure. This can cause **severe frost bite**.



WARNING !	
➤	Nitrogen may cause suffocation by displacing the oxygen in air. Ensure levels of <i>at least 19.5% Oxygen</i>
➤	Liquid Nitrogen has <i>extremely cold</i> temperatures of -196°C (-320°F)

Contact with liquid Nitrogen may cause skin frost burns and severe eye damages.

On vaporization Nitrogen expands by a factor of 700; one liter of liquid nitrogen becomes 0.7 cubic meter (24.6 cubic feet) of nitrogen gas. This can cause the **explosion** of a sealed container, or it can displace oxygen in the room and cause **suffocation without warning**. Nitrogen can also become oxygen enriched and cause ordinarily noncombustible materials to burn rapidly.

In case of an accident evacuate all personnel from the affected area. Persons suffering from lack of oxygen should be removed to fresh air. If victim is not breathing, use trained personnel to administer a supplemental oxygen supply and artificial respiration to support vital functions. If breathing is difficult, administer oxygen. Victim and rescuers must seek immediate medical attention.

Ventilate area and attempt to shut off the release of gas by tightening the main valve. If it is not possible to stop the release of gas, allow the gas to be released there. If leaking from cylinder or its valve, contact your supplier. Monitor area for a minimum of 19.5% oxygen content before allowing re-entry by personnel.

In case of frostbite, restore tissue to normal body temperature, 37°C (98.6°F), followed by protection of the injured tissue from further damage and infection. Immediately place the frostbitten part in warm water (not to exceed 40°C) or wrap affected parts gently in blankets. Under no circumstances should the water be over 44°C (112°F), nor should the frozen part be rubbed either before or after re-warming. Remove or loosen clothing that may constrict blood circulation to the frozen area. In case of massive exposure, remove clothing while showering the area with warm water. Encourage victim to gently exercise the affected part while being warmed. Call a physician. The patient should neither smoke, nor drink alcohol.

7.1.5 Refill LN2 Liquid Nitrogen cylinder

Whenever working with liquid Nitrogen use of personal safety equipment is required. Thermal gloves and protective glasses have to be worn at least.

Refill interval of LN2 cylinder is depending on the required minimum backup time and the available LN2 cylinder volume. All cryogenic cylinder do have a certain leakage rate which will define the time after which the minimum filling level of the tank is reached. The filling level is shown by a gauge mounted next to the connection points on the cylinder. The actual design may vary depending on cylinder manufacturer.

Before disconnecting the connection, hose close the pressure builder valve, the shut off valve on the cylinder and the shut off valve on the connection point on the actual storage chamber. Use two suitable spanners to loosen the connection on the chamber (or on the cylinder depending on refill procedure). Usually the cylinder is then moved to a refill station and refilled with LN2. Depending on cylinder manufacturer the process may vary. Please refer to the manufacturers cylinder manual for further details.

To reconnect the cylinder with the system, proceed in the reverse way to the disconnecting procedure. Connect back the hose. Open the main shut off valve on the cylinder, open the shut off valve on the storage chamber and open the valve on the pressure builder. The pressure builder valve has to stay opened in order to ensure proper operation of the LN2 backup option.



WARNING!

- Wear personnel protection when disconnecting, refilling and reconnecting LN2 cylinder.
- Ensure the shut off valves are closed when disconnecting the cylinder.
- Refer to cylinder manufacture manual for exact refill procedure



CAUTION !

- Shut off valve of pressure builder has to stay open as long as the cylinder is connected to the storage.

Manual Operation

8. Alert System

The Biolix FAB Hybrid has a combined acoustic / visual alert system. An alert occurs when one or more abnormal statuses occur or when interaction is required. When the system is operating properly there is no alert. The various alerts are distinguished by the alert signal duration and the pause between the signals.

8.1 FAB Alerts

The storage area of the Biolix FAB Hybrid does not allow manual access, therefore the following alerts are defined:

Signal / Pause (time in seconds)	Alert	Comment, Action
0.1 / 2.4	No Initialization	StoreX not initialized. Press Multi Function Switch for initialization.

8.2 Interface Alerts

The interface unit does allow manual access. Therefore additional alerts are defined:

Signal / Pause (time in seconds)	Alert	Comment, Action
0.1 / 2.4	No Initialization	StoreX not initialized. Press Multi Function Switch for initialization.
0.2 / 0.4	Glass Door Timeout	Close Glass Door or press Multi Function Switch to cancel alert status.
0.5 / 0.5	Access collision	Occurs when Glass Door is opened and shovel is extracted. This alarm indicates high risk of damage to the handler. Do not rotate carousel. Check shovel position before moving cassettes. Use extreme caution as shovel may be trapped in a cassette.
0.1 / 0.1	System Busy Access	Glass Door is opened during a remote access. Close Glass Door and wait for remote access to be finished.

8.3 Tube Handling Alerts

The Tube Handling is located inside the interface unit and has the possibility for individual alarm notifications

Signal / Pause (time in seconds)	Alert	Comment, Action
0.1 / 2.4	No Initialization	StoreX not initialized. Press Multi Function Switch for initialization.

9. Barcode Reader

9.1 1D Reader for racks and plates

The Barcode reader for plate/rack identification is mounted onto the handling mechanism.

The Barcodes must be placed on the shorter side of the plates and must face towards the open side of the cassette. The barcodes should be parallel to the plate's lower edge. The barcode label should be centered both vertically and horizontally. On higher plates (e.g. deep well plates) place the barcode further down. Preferably barcode labels should be at the same height independent of the plate height. Barcode reading reliability is improved when the barcode is not covered by the plate's lid.



WARNING!

- Laser Class 2. Laser light - do not look into the beam.



DANGER!

- May be harmful to your eyes.

Use barcode testing device to verify barcode quality. Quality Class A, B or C are required. Identification of Class D is not guaranteed. For sufficient print quality use barcodes printed by thermal transfer or photographic methods. The barcode label surface should be mat and clean. Do not use yellowed, dirty or damaged barcodes

9.2 2D Rack Scanner / Reader

The 2D Scanner / Reader for tube identification is located in the interface unit.

The 2D codes must be placed on the bottom of the tube. The 2D reader operates either on a scanner or camera-based principle. If a camera is used it requires lighting by short flashes to take pictures. These flashes may be a potential trigger for people with photosensitive epilepsy.



WARNING!

- A few people may experience epileptic seizures when viewing flashing lights or patterns. Avoid watching the 2D code reading for longer time.

Use barcode testing device to verify barcode quality. The code label surface should to be mat and clean. Do not use dirty or damaged barcodes.

10. Cassettes

10.1 Interface Cassettes

Cassettes allow simple and comfortable loading and unloading of storage samples and can be prepared outside the climate chamber. Once prepared, the samples can be quickly transferred into the climate chamber of the Kiwi unit.

There is a wide variety of cassette types available. Make sure that you work with the proper cassette size that matches the type of plates you are using.



CAUTION!

- Do not add, bend or remove support rails.
- If cassettes with different pitch height are used within the same system, make sure a prior removed cassette is put back in exactly the same position. Failures being generated like that, will in destinations not found or crashes.
- Only a trained System Integrator may alter the instrument configuration and reset the lift accordingly.

The cassettes are open at their front for loading.

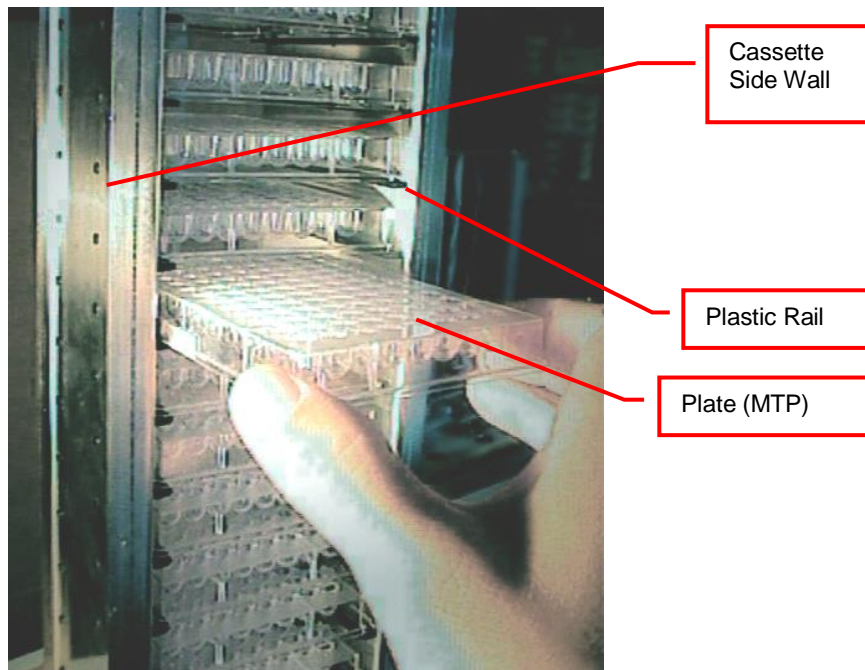

To put a plate into the cassette, choose the level and slide the plate along the rails towards the back of the cassette. Slightly lift the front of the plate to avoid excessive wear of the retaining nozzles at the front end of the rails. When the plates are loaded make sure that they are all pushed towards the back of the cassette. Plates that jut out may cause collision with the handler and may result in damage to the handler.

Cassettes must be treated with great care. They are aligned within 1mm when leaving the factory. Misaligned cassettes must be returned for re-alignment. Misaligned, tilted or bent cassettes may cause handling failures. Special care must be taken when cassettes are fully loaded with plates.

The carousel must be kept clean as particles may cause the cassette to tilt. Do not place cassettes on the floor as they may pick-up dust etc. Always store cassettes inside the climate chamber or on clean surfaces.

Use the cassette handle for transport of the cassettes. When lifting the cassette by its handle it will tilt backward slightly in order to prevent plates from shifting to the front.

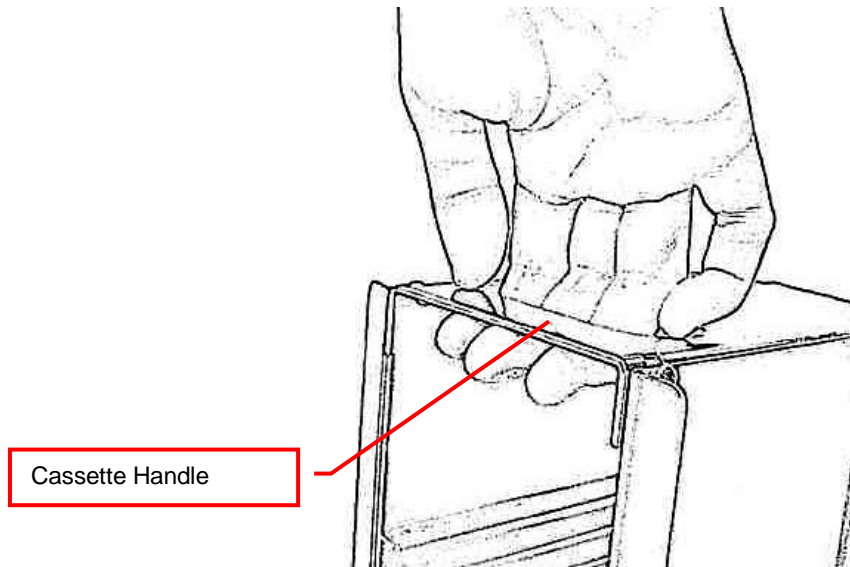

Never apply force to the cassettes. Do not drop a cassette as mechanical shock will misalign it. Never lift a cassette by its side walls. This may bend the side walls of the cassette. Bent side walls cause the plates to block when being loaded or unloaded.

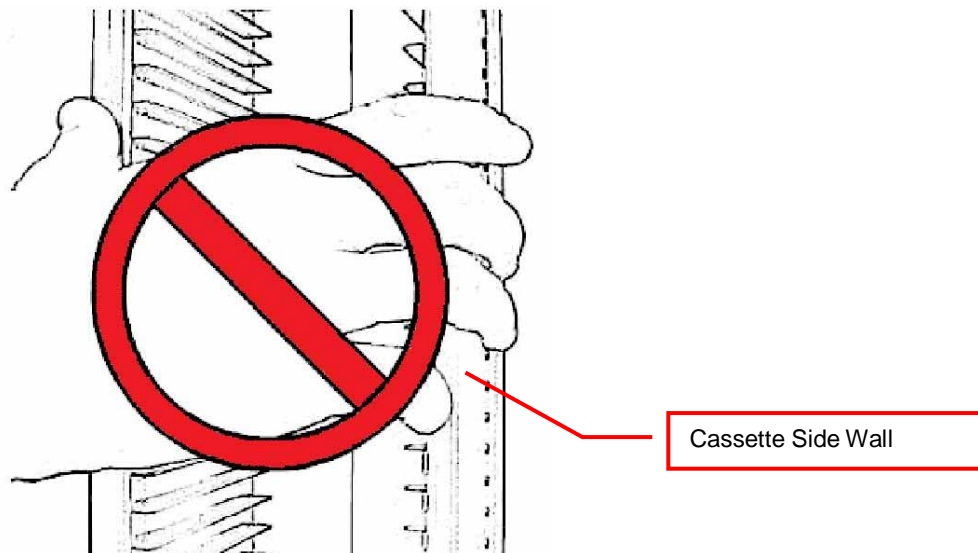

In the rare event of a blockage with the extended shovel in the cassette, the shovel must be carefully pushed backwards until it can move freely. Then the cassette can be removed.

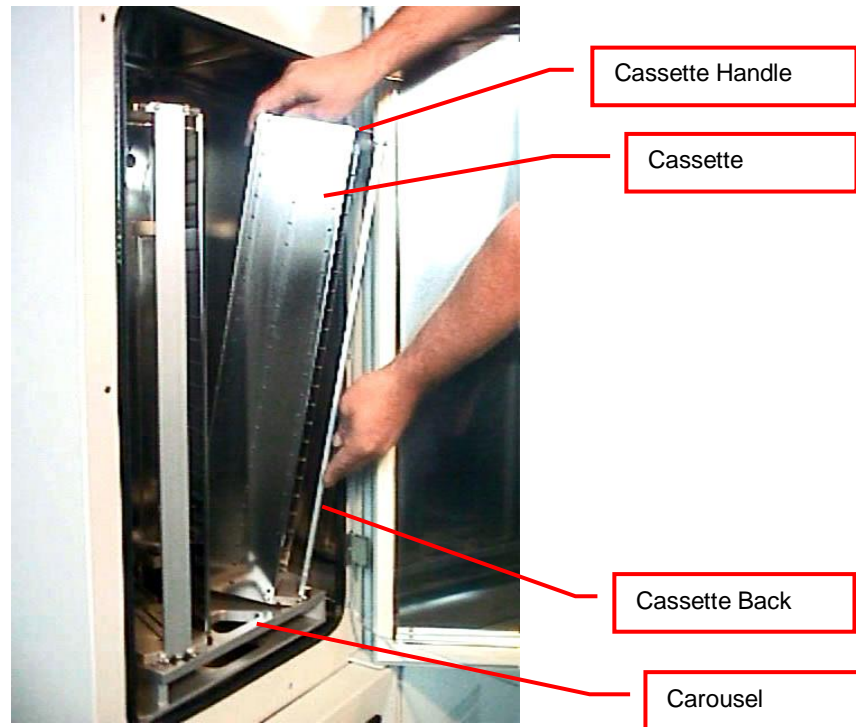

The cassettes are secured by alignment rails to the carousel. The cassettes may be tilted slightly backwards (towards the front opening) for removal. In order to load a cassette align the back of the stacker base plate to the cassette alignment rail. Push the cassette forward until it stands vertically. The cassette should now stand firmly on the cassette plate. There should be no movement.

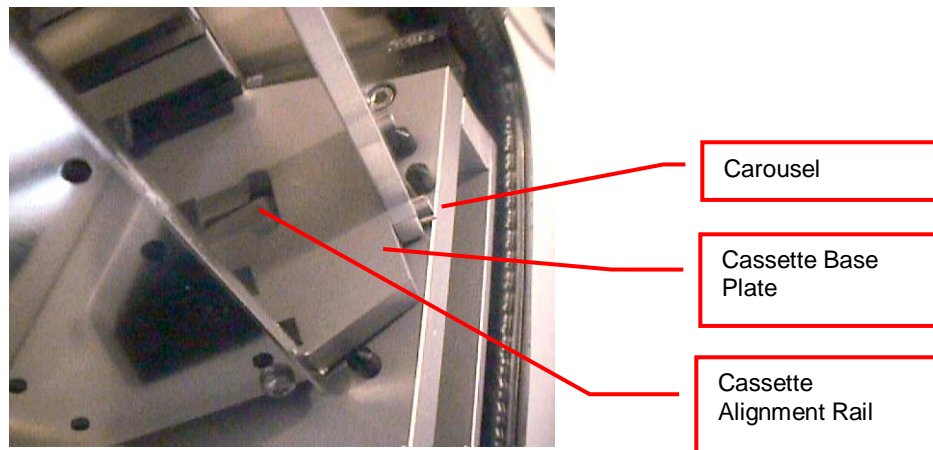

To remove a cassette pull the stacker handle slightly backwards, tilting it, then lift the cassette until it loosens from the cassette alignment rail. Use both hands for this operation. Never use force.



CAUTION !

- Make sure that ALL plates are pushed to the back of the cassette. Plates jutting out the front side of the cassette may cause collision with the handler shovel.
- Lift cassettes by their cassette handles only
- Do not drop cassettes. Misaligned cassettes can cause handling errors
- Do not autoclave cassettes with plastic rails. Use disinfecting solution for sterilization. All stainless steel cassettes may be autoclaved.
- Keep cassette plate clean. Particles may tilt cassettes

10.2

10.3 FAB Store Cassettes

Customized FAB cassettes allow simple and comfortable loading and unloading of storage samples. Once prepared, the samples can be quickly transferred into the climate chamber of the FAB unit by means of the cassette lifts installed.

There is a wide variety of cassette types available. Make sure that you work with the proper cassette size that matches the type of plates or Cryo Boxes you are using.



CAUTION !

- Do not add, bend or remove support rails.
- If cassettes with different pitch height are used within the same system, make sure a prior removed cassette is put back in exactly the same position. Failures being generated like that, will result in destinations not found or crashes.
- Only a trained System Integrator may alter the instrument configuration and reset the lift accordingly.

The SAB cassettes (see picture below) are open at their front for loading.

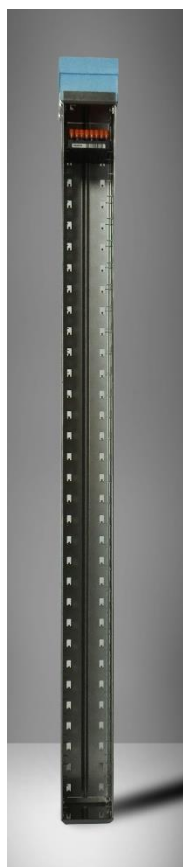

To put a plate into the cassette, choose the level and slide the plate along the rails towards the back of the cassette. Slightly lift the front of the plate to avoid excessive wear of the retaining nozzles at the front end of the rails. When the plates are loaded make sure that they are all pushed towards the back of the cassette. Plates that jut out may cause collision with the handler and may result in damage to the handler.

Cassettes must be treated with great care. They are aligned within 1mm when leaving the factory. Misaligned cassettes must be returned for re-alignment. Misaligned, tilted or bent cassettes may cause handling failures. Special care must be taken when cassettes are fully loaded with plates.

Never apply force to the cassettes. Do not drop a cassette as mechanical shock will misalign it. Never lift a cassette by its side walls. This may bend the side walls of the cassette. Bent side walls cause the plates to block when being loaded or unloaded.

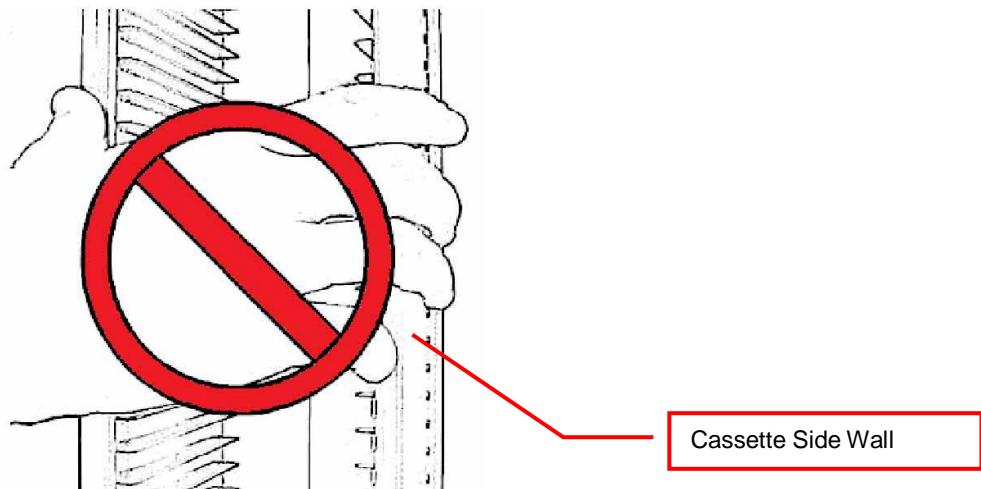

The plates / tube racks or Cryo Boxes are presented to the operator by means of the cassette lifts shown in the pictures below :





CAUTION !

- Make sure that ALL plates are pushed to the back of the cassette. Plates jutting out the front side of the cassette may cause collision with the cassette lift.
- Lift cassettes by their cassette handles only
- Do not drop cassettes. Misaligned cassettes can cause handling errors
- Do not autoclave cassettes with plastic rails. Use disinfecting solution for sterilization. All stainless steel cassettes may be autoclaved.
- Keep cassette clean. Particles and ice could prevent reliable handling.

11. Power-On Interface

The instruments power is activated by the main switch. The instrument is turned on by pressing the power switch located at the front of the instrument. After power-on the climate portion of the instrument is activated automatically. An alarm will sound. If the green light of the power switch does not turn on, check the main switch at the back of the instrument or the fuse in the mains supply.

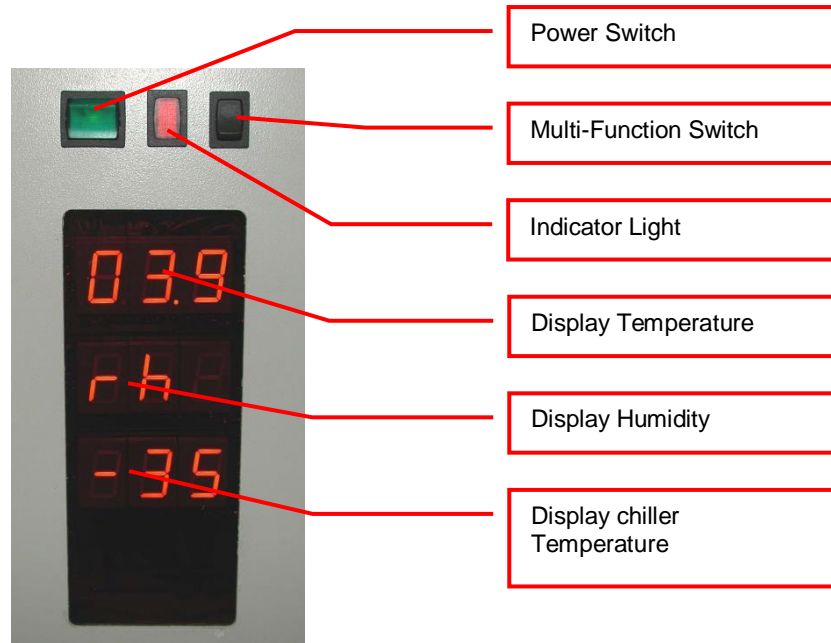

The alarm indicates that the handling is not activated. In order to activate the handling, the black multi-function switch has to be pressed. The multi-function switch will cause the handling to initialize. Take note the gate - if opened- is closed after pressing the multi-function switch. Pressing the multi-function switch is equal to sending an external activate command through the software.

It is normal for some condensation to occur during start-up. This condensation will disappear once the internal climate is stabilized. The settling time may take several hours.

The temperature inside the climate chamber is displayed on the temperature display. The temperature display may not be used to set temperature. The operating temperature can only be set through the communication port.

Toggle Multi-Function Switch	Function	Description
Toggle (< 1sec) (after power on)	Initialize	Unit initializes
Toggle (< 1sec) (Unit initialized)	Carousel turns one position further	Carousel turns to the next cassette position. (STT1k0 only)
Hold (Unit initialized)	Carousel turns	Carousel turns till switch is released (STT1k0 only)
Hold in case of Alert (10sec)	Acknowledge Alert	Check system for cause of Alert

12. Power-On FAB Store

The instruments power is activated by the main switch. The instrument is turned on by pressing the power switch located at the front of the instrument. The climate portion of the instrument is activated Independently. An alarm will sound. If the green light of the power switch does not turn on, check the fuse in the mains supply.

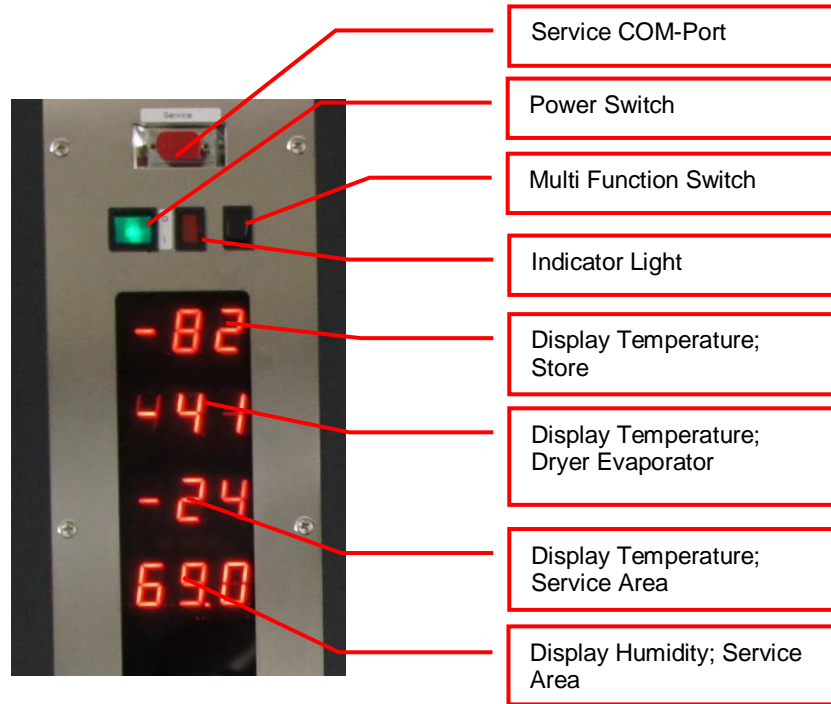

The alarm indicates that the handling is not activated. In order to activate the handling, this has to be triggered out of the controlling software.

The temperature inside the climate chamber is displayed on the temperature display. The temperature display may not be used to set temperature. The operating temperature may be adjusted through the Software.

Toggle Switch	Multi-Function	Function	Description
Toggle (< 1sec) (after power on)		Initialize	Unit initializes
Hold in case of Alert (10sec)		Acknowledge Alert	Check system for cause of Alert

13. Cooling unit operation

13.1 Switch on cooling STC ULT

The cooling units should stay switched on all the time. Initial power up of cooling should be performed with switched off handling of store. All cables should be connected before start up.

To switch on the cooling unit the main power switch needs to be turned into the position stating ON. The key switch has to be in automatic position (see Picture 1). This has to be performed on both cooling units main and auxiliary.

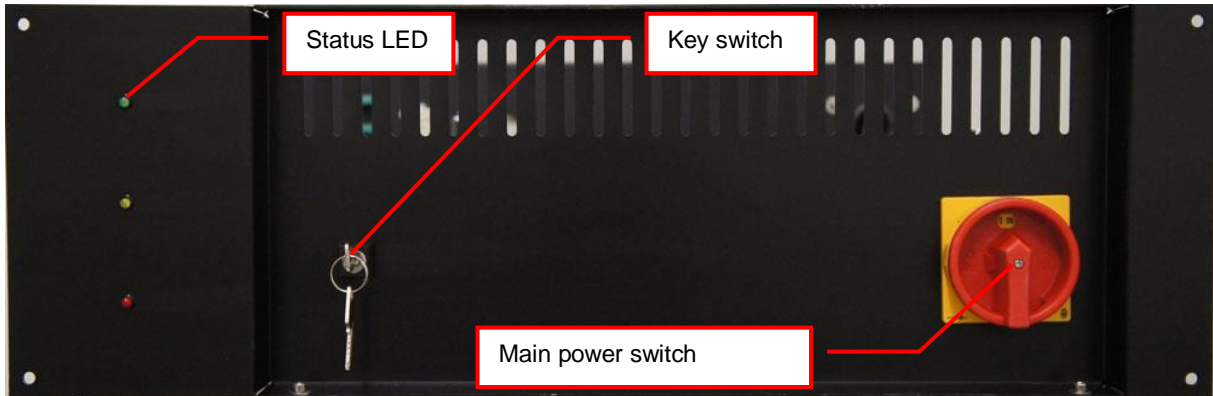

Picture 1: Cooling unit front view

The first cooling stage of the cooling unit will immediately start to operate. The green status LED therefore indicates all conditions fulfilled to run first stage. After a certain time the second cooling stage will kick in. The yellow status LED therefore indicates all conditions to operate the second stage are fulfilled.

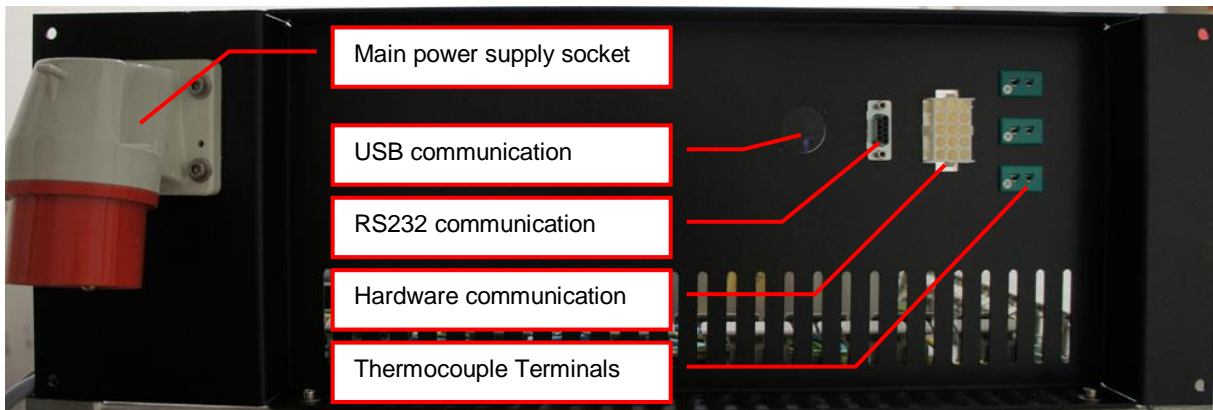

Picture 2: Cooling unit back view

In case of an error the red status LED will be lit. If the error conditions are resolved check the section “Recovery after backup activation” for the procedure to return in to normal operation.

Status LED	Permanent	Blink slow	Blink fast	Blink intermittent
RED	No HV (high Voltage)	General Error	Warning Reset	
ORANGE	1 st Stage ON	1 st Stage Enabled	1 st Stage over Temperature	1 st Stage over Pressure
GREEN	2 nd Stage ON	2 nd Stage Enabled	2 nd Stage over Temperature	2 nd Stage over Pressure



CAUTION !

- Do not disconnect any cables, except a LiCONiC engineer did advise to do so.
- All cooling units have to be permanently switched on.
- The key switch has to stay in automatic position, for normal operation.
- Ensure normal conditions (p.e.: Power and Water) before switch on the cooling units.

13.2 Recovery after Backup activation

In the case the backup cascade was activated and the system is running on one off the backup options a recovery might be necessary. The recovery procedure should only be performed after normal conditions for main cooling are restored.



CAUTION !

- Ensure normal conditions being restored to operate the main cooling
- Ask for assistance from a LiCONiC engineer in case of insecurity about normal conditions and performing the recovery procedure.
- Observe cooling after recovery. Contact immediately a LiCONiC engineer in case of repeated stop of cooling after recovery.
-

13.2.1 Procedure

STC ULT System running on auxiliary cooling

- Ensure normal operation conditions being restored. Optimal reset point would be system returned to target operation Temperature.
- Toggle the key switch of main cooling (move key switch out of normal position and back again)
- Auxiliary cooling should stop now and the red alarm light of main cooling should switch off

STC ULT system running on gas backup

- Ensure normal operation conditions being restored. Power and Water for electric cooling units available.
- Toggle the key switch of aux and main cooling (move key switch out of normal position and back again)
- Either Main only or both cooling units will operate. When Target operation Temperature of the Storage is reached toggle the key switch of the main cooling again.

13.3 Service operation of backup cooling

In the case it is required to run the backup cooling to maintain the main cooling or perform modifications on water cooling the backup cooling may be switched on manually.



CAUTION !

- Ensure normal conditions being restored to operate the main cooling
- Ask for assistance from a LiCONiC engineer in case of insecurity about normal conditions and performing the recovery procedure.
- Observe cooling after recovery. Contact immediately a LiCONiC engineer in case of repeated stop of cooling after recovery.
-

13.3.1 Procedure

STC ULT backup cooling switch to manual operation

- Turn key switch into horizontal position (Manual mode)
- The first stage will switch on immediately. The second stage will kick in after about 15 minutes (yellow and green light lit)
- When Second stage is operating switch off main cooling

STC ULT restoring normal operation

- Ensure normal operation conditions being restored. Power and Water for electric cooling units available.
- Switch back on main cooling. Key switch positioned in in vertical position
- When main cooling is back into normal operation (yellow and green light lit) switch back key switch of backup cooling into horizontal position.

14. Climate Settings

14.1 Temperature Settings

System Temperature is pre-set. Temperature should only be changed by a qualified system administrator or LiCONiC engineer.

14.2 Humidity Settings

Humidity is kept as low as possible and is not adjustable.

15. Routine Safety Checks

Carefully read all safety instructions before operating the instrument. Be sure that you fully understand their content. Although the KIWI STORE is intended to be operated as a remote-controlled system, there still are some manual interactions required for operation. Apart from these operations there are also some very important safety checks the operator should be familiar with.

The operator should regularly read the display readings and check whether they match the desired values. Readings like “0.00” or “9.99”, readings that are far out, instable or that differ over long periods of time could indicate a malfunction of the instrument or could be caused by faulty settings of the system.

The electrical cables should be routinely inspected for wear, defects or contusion. There should be no mechanical tension on any cable. Broken connectors should be replaced immediately. All electrical installations should be kept clean and well protected from water and humidity.

The same applies to cables and gas tubing. They should be free of mechanical tension and should show no signs of wear or contusion. Sharp bends should be avoided under all circumstances. All fittings should be secured. Missing security nuts must be reinstalled immediately. Any broken pneumatics parts must also be replaced immediately.

The mechanical appearance of the instrument should be clean and “straight”. All movements should be smooth and precise. Watch out for unusual noises as these may indicate misalignments or mechanical wear.

Seals should close the chamber firmly. Check seals by placing a piece of paper between the seal and door. When trying to pull on the paper, there should be an even resistance. Check the seal on the glass door, gate and front door.

Condensation, mainly on the front glass door, presents a possible severe danger as it may lead to water flowing into the electrical parts of the instrument. When cooling, excessive condensation on the glass door will occur when the front door is open over a long period of time. Furthermore, it may also indicate a faulty heater or high environmental humidity.

Icing on a gassing tube or on a pressurized gas cylinder indicates excessive gas flow and therefore severe danger. Once icing has been observed leave the room immediately and call for help. Do not try to locate the source of the problem or try to fix it. The room may already be contaminated.



WARNING!

- Icing on the gas cylinder or other parts of the gassing system indicate excessive gas flow.
- In the case of such icing leave the room immediately and call for help
- Do not try to locate the source of the problem or try to fix it

Software

16. Sample Management Software

16.1 Order File

The order file is used to retrieve specific samples from the storage system. Two types of order files can be used to execute order jobs. The first type is the simple order file containing only 1D or 2D codes or ID's of tubes/racks to be retrieved. The second type is more complex, allowing more functionality. Refer to the following chapter for a detailed description of the files.

In an integrated environment such as a connection to a LIMS system the pick orders are sent through a direct connection to the Liconic System. These files are only used in a stand alone configuration.

16.1.1 Simple order file

In case of the simple order file, the file is a simple list of 1D barcodes for plate orders only. For tube orders 2D barcodes/Sample ID's, or a mixture of both can be used. These files can be passed onto the system as CSV (Comma Separated Values) file. They can be populated manually by a user or exported from MS Excel© or a database. Picture 3 below shows an example of a simple order file for tube picking.

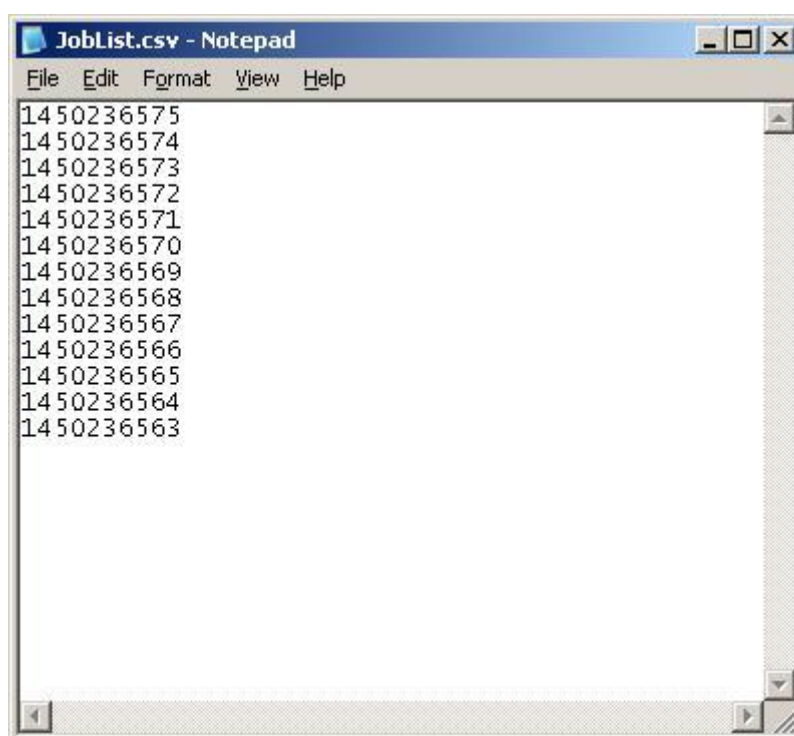

Picture 3: Sample order file

16.1.2 Complex order file

In case of the complex order file, the file consists of a parameter list. This file can be passed onto the system as a CSV (Comma Separated Values) file. The file can be populated manually by a user or exported from Excel© or a database too. Picture 4 below shows an example of a complex order file.

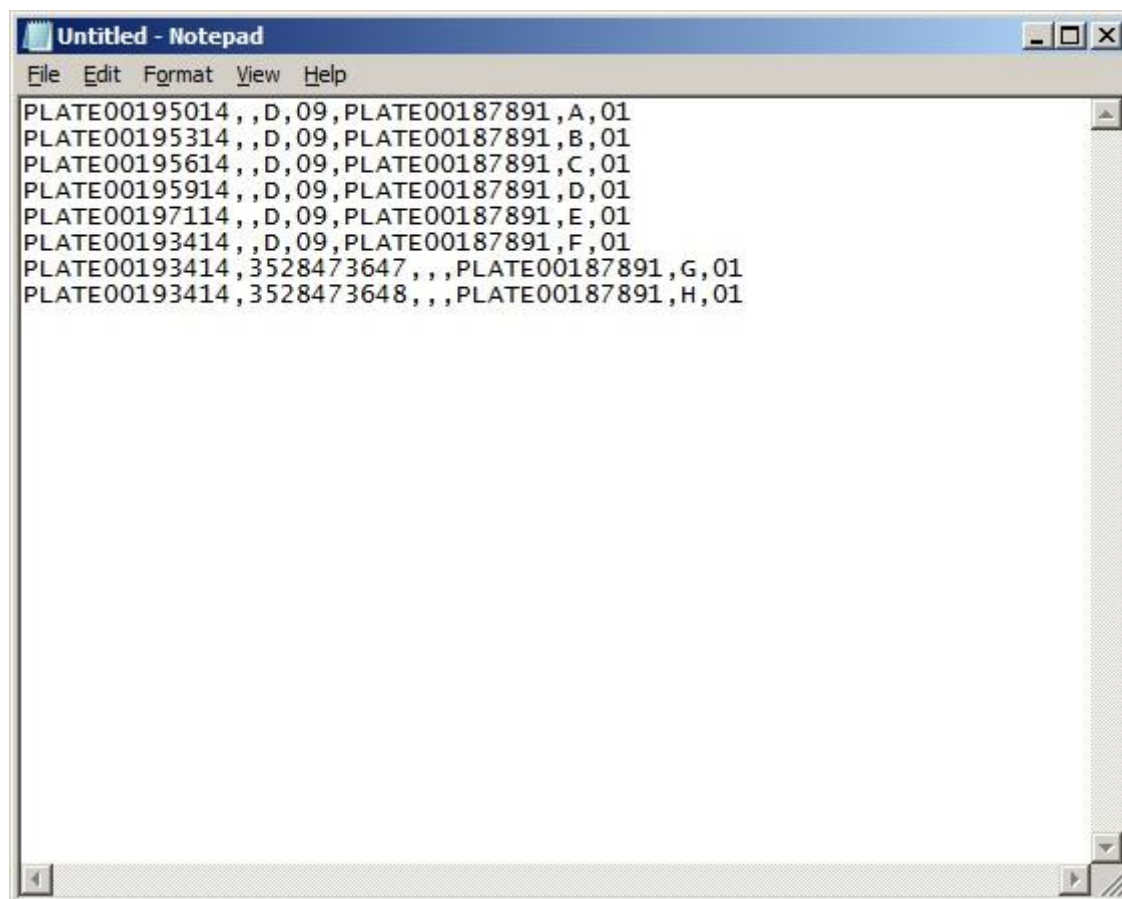

Picture 4: Complex order file

A parameter line consists of the following items:

- Barcode(1D) or explicit name of the source rack,
- 2D Code(2D) or explicit name of the tube to be picked,
- Row of the picked tube on the source rack, (e.g.: A-H)
- Column of the picked tube on the source rack, (e.g.: 1-12)
- Barcode(1D), explicit name or generic name ([Rack_1],[...]) of the target rack,
- Row of the picked tube on the target rack, (e.g.: A-H)
- Column of the picked tube on the target rack (e.g.: 1-12)

16.2 Import – Export Interface

The Liconic Import and Export interface is used to create and execute operations with the result to load samples to the system or unload them from the system. In stand-alone configuration this can be used to introduce samples to the system, start pick orders and unload samples from the system.

In combination with a LIMS system this interface will be used to trigger loading or unloading operations. The actual creation of the jobs is done by the LIMS and handed over to the Liconic System.

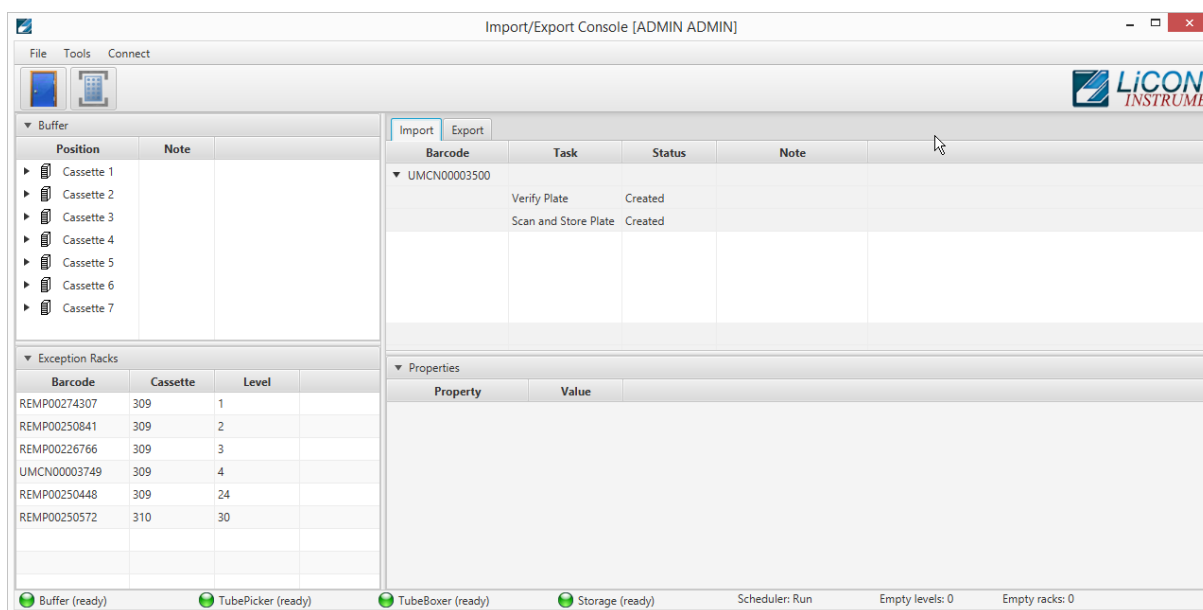

Picture 5: Overview Import - Export Interface

16.2.1 Import

The import view provides an overview of all registered jobs for loading plates into the system. One import job can consist of several tasks. The application allows to create import jobs with tasks. A listing of the possible tasks is provided at the chapter Create Import.

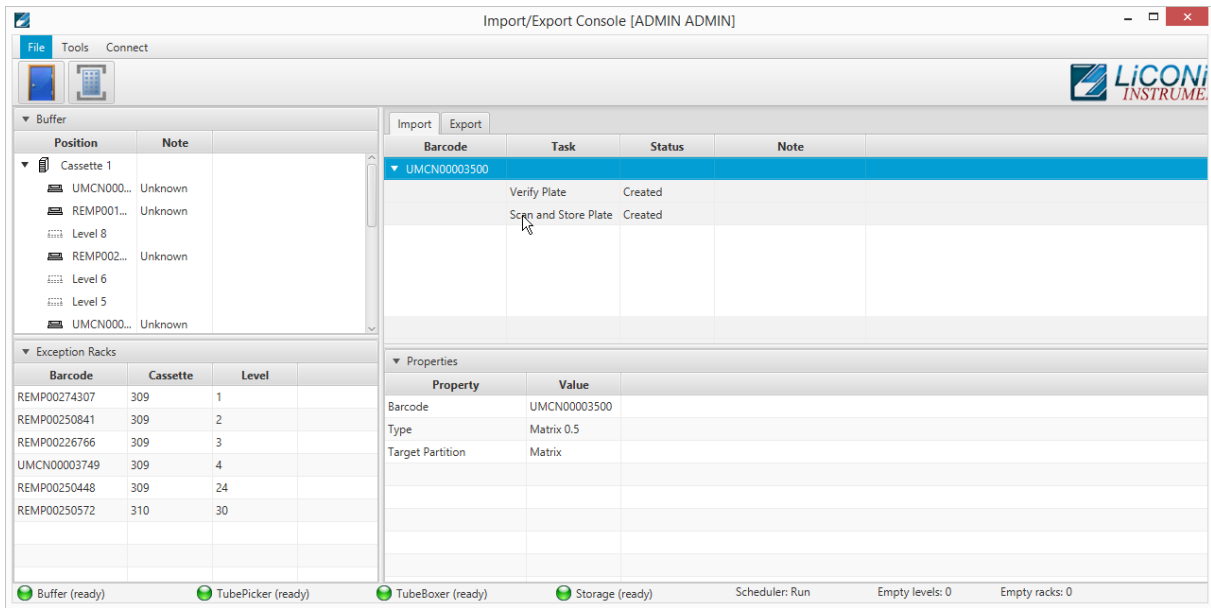

Picture 6: Import View with Rack details

Selecting the import job, provides a detailed view of additional information in the “Properties” view (See Picture 6: Import View with Rack details). Information such as barcode, lab ware type and target storage partition are displayed.

By right clicking on the import job it is possible to delete a created job. The job will then be removed from the queue and all associated information will be cleared off the system.

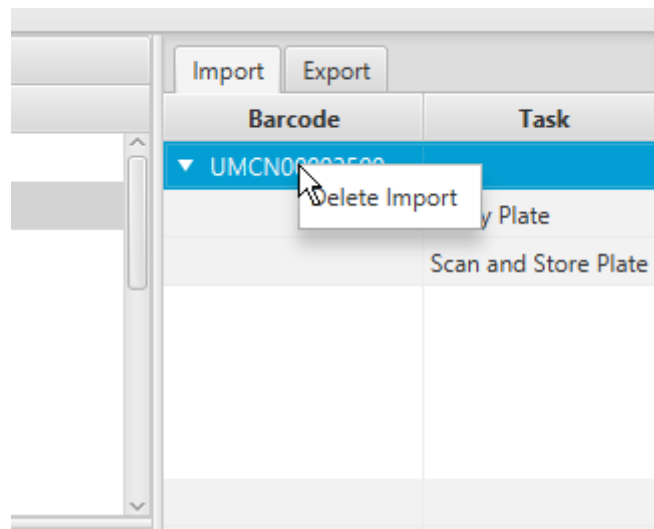

Picture 7: Deleting a created Import Job

A already started job cannot be deleted directly as operations had already been started and put in to pending state. Import jobs can be deleted in “Created” and “Stopped” state.

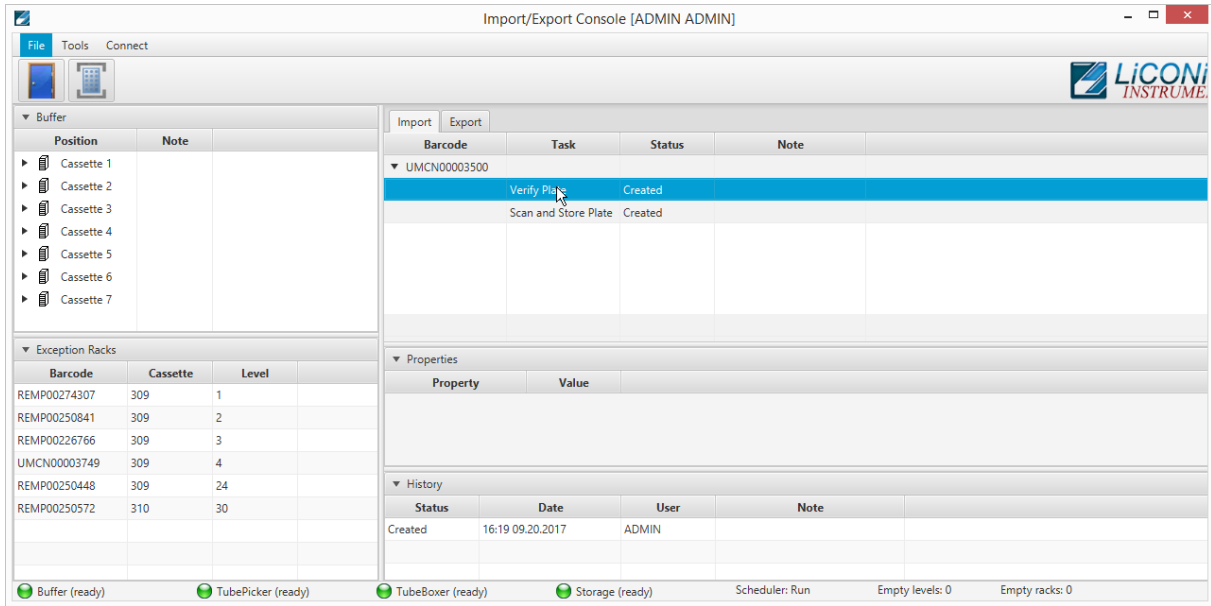

Picture 8: Detail Information on Task 1

By selecting an individual task of an import job additional information and properties are shown. The shown information depends on the current state each task is in.

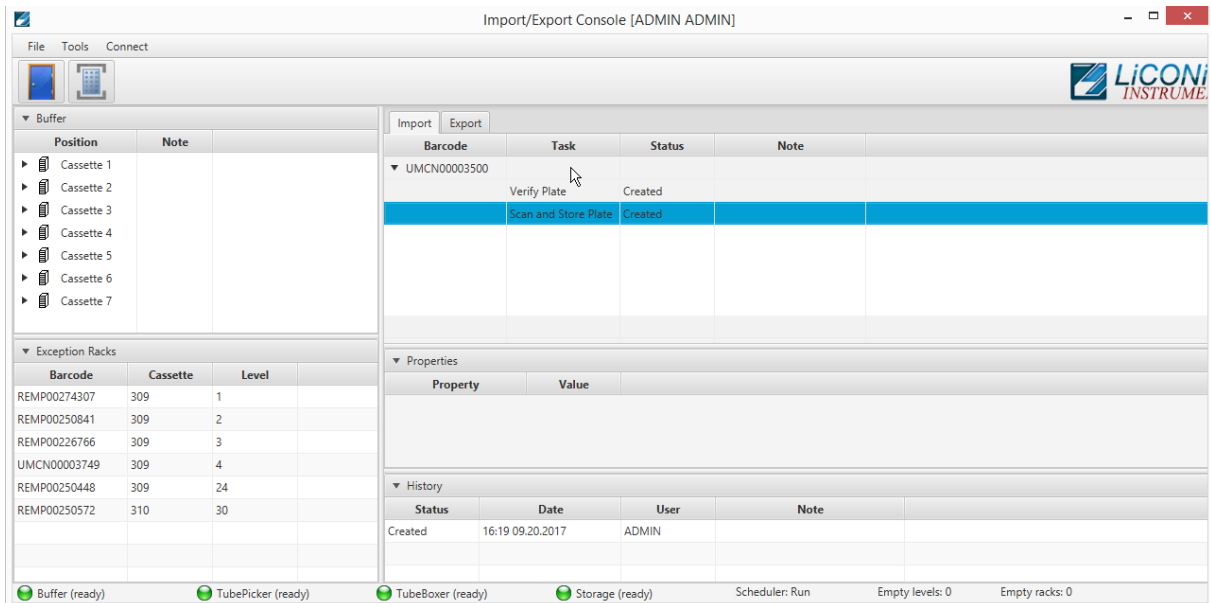

Picture 9: Detail Information on Task 1

In the “History” section of each task the history of selected task is shown. Information such as which user did trigger which state of the task and the associated date to the status change.

Create Import

The Import – Export Interface does allow to create import jobs. To do so the menu entry “Tools” is selected and in there the entry “Import Plate” is selected. This will call a dialogue to enter details and select the properties for the import.

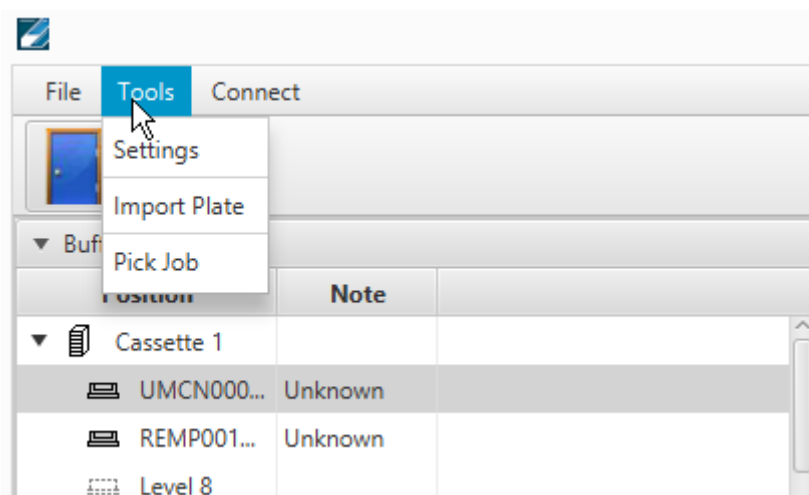

Picture 10: Tools Menu Import

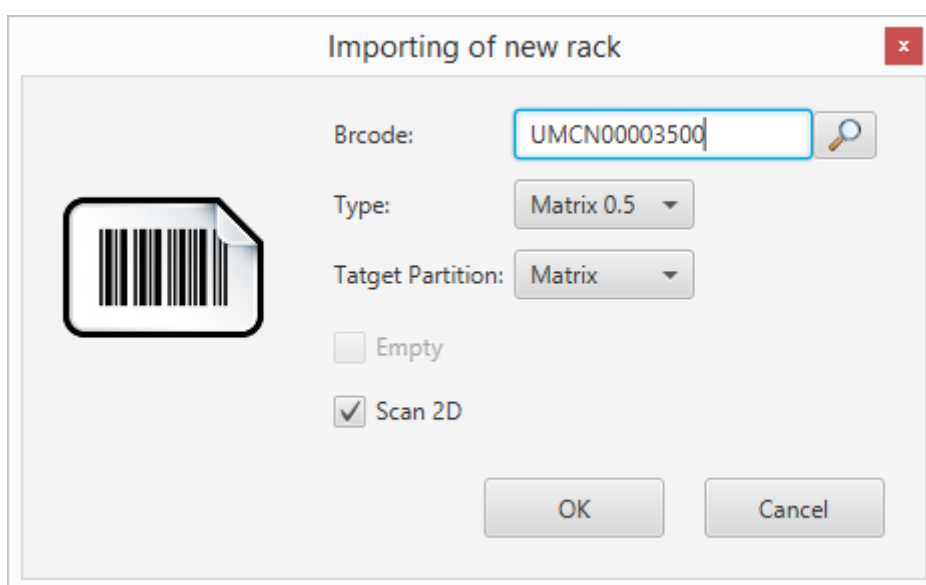

Picture 11: Import Plate Dialogue

The import dialogue will require to enter a barcode of the plate going to be loaded to the system. This is required for the system to recognize the plate and associate the given information to it.

By clicking onto the “Magnifier Glass” icon the windows file open dialogue is opened. This will allow to search for a content file on the computer or drives connected to this computer.

The “Type” menu allows the selection of the lab ware type. The menu will only provide the lab ware types the system is configured for. The lab ware type can not be changed once the plate has been introduced into the system. If the lab ware type has be set wrongly the import has to be deleted and created newly. If the palate has already been entered into the system, the plate has to be removed and newly imported.

Selecting “Target Partition” does allow to define the final storage location of a plate. The partitions correspond to the configuration of the system.

Chose the check box “Empty” if a plate containing no tubes is going to be loaded to the system. Empty plates may be used as target in case of a pick order.

Chose the check box “Scan 2D” to include a 2D scanning step in the import. Should there be content provided for the plate, the scan step will compare the provided content with the physical present content. In case of a discrepancy the plate will be stored in a suitable safe area. Further details in the chapter Exception Racks.

Pressing “OK” will create the import job. The job is now listed in the import queue list. Pressing “Cancel” will close the dialogue and no further action is triggered.

Trigger Import

To trigger an import either the door icon or the transfer station icon has to be pressed. The door icon will show a dialogue and guide through the steps of loading samples through the user door into the buffer cassettes.

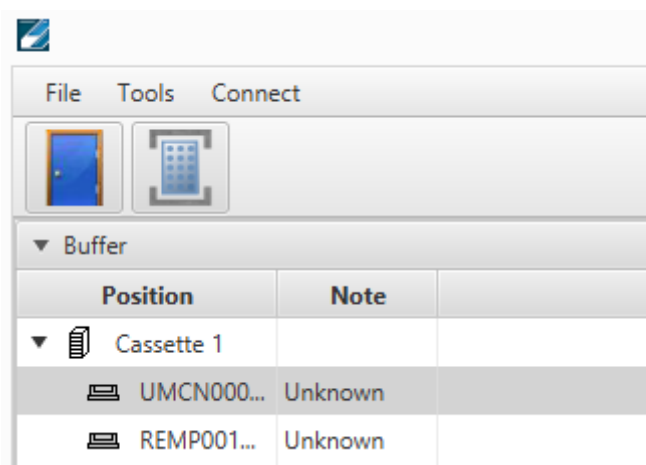

Picture 12: Icons to trigger Import

The dialogue will tell when you need to open the user door. After closing the door the system will perform an inventory of the buffer. All known plates with an import job will be treated according to the selected options.

Prior to selecting the transfer station icon a plate needs to be set to the transfer station. As soon as the icon is clicked the system moves the transfer station into the unit. The barcode is checked and the plate moved into the unit if the barcode is known. The plate will be processed as selected. Should there be a unknown barcode or the barcode not be readable the system will refuse the plate and send it back out. The software will show an error message in this case.

16.2.2 Export

The export view provides an overview of all registered jobs for collecting individual samples and plates to be unloaded. One export job can consist of several tasks. The application allows to create export jobs.

Create Export

Selecting in the Tools menu the entry “Pick Job” will open up the Windows file dialogue. A pick file can be selected. After opening the file the export task is listed in the Export queue

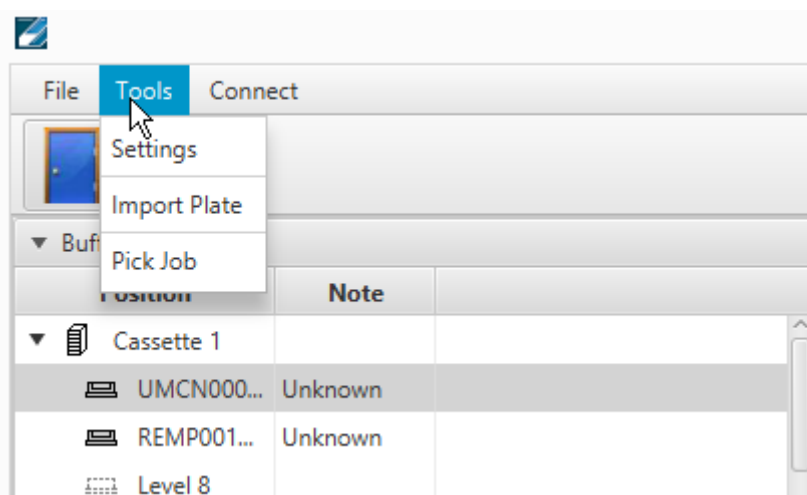

Picture 13: Tools menu Pick Job

Export Interface

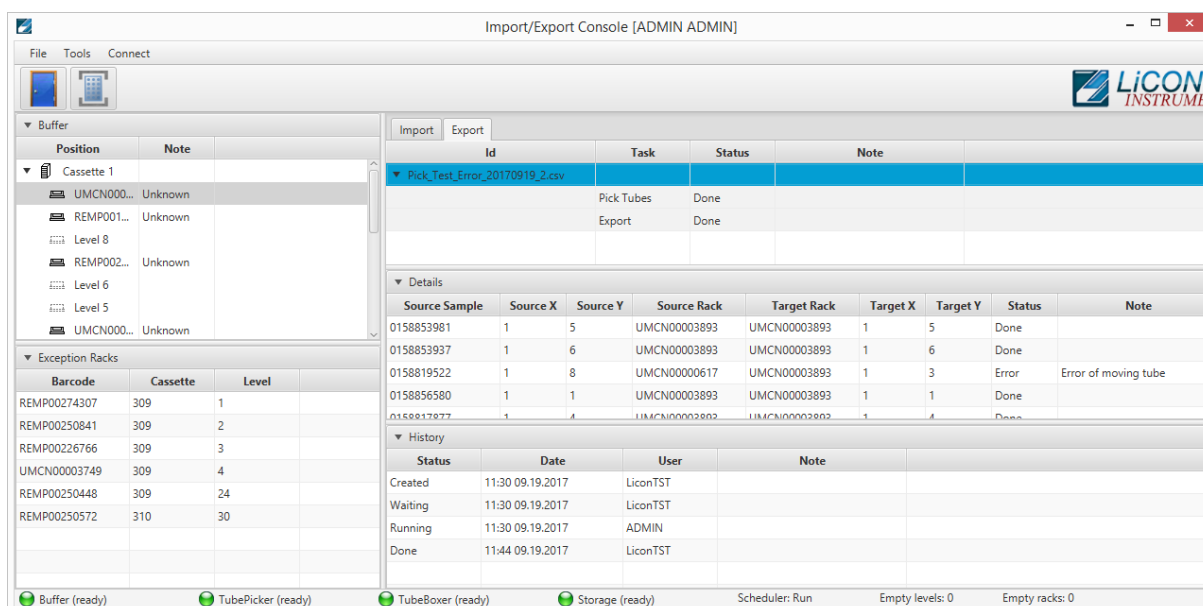

Picture 14: Import - Export Interface Export-View

Selecting one export job will provide additional detail information in the “Details” view. In case of a sample pick order the list of samples is provided. In the “History” view the status of the job and the status changes, who triggered the changes and when they were changed are listed.

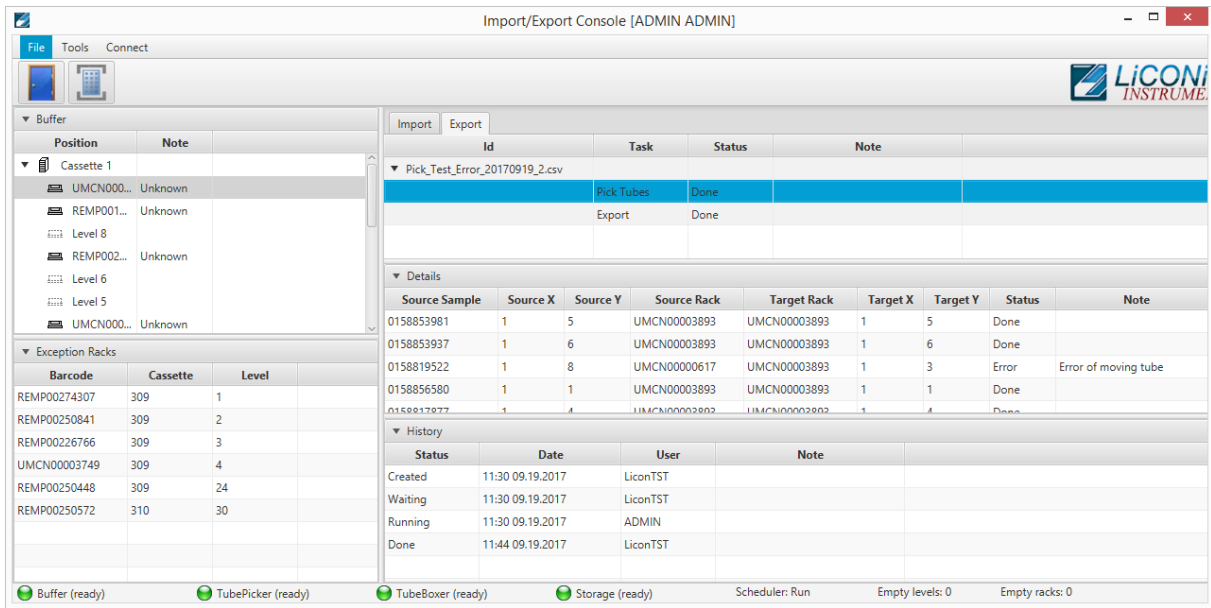

Picture 15: Export Task Detail 1

If the actual pick task is selected the detail view varies according the state the pick task is in. In the created state only the list of tubes is shown. During the running state tubes vanish according them to be moved within the progress of the pick task. In the done state all tubes are listed with their target position and the status.

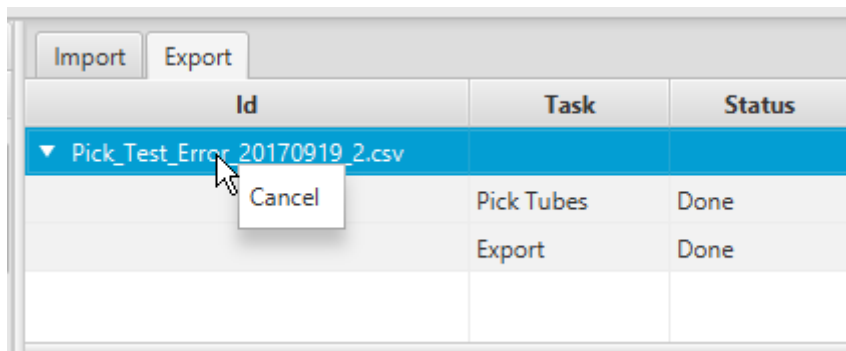

Picture 16: Cancel a export job

A complete job can be canceled in the states created and done. In the case of canceling the job in the created state the job will be removed from the queue and no samples will be moved. Is the job canceled in the done state the already collected samples will stay in the target plate they had been moved to.

Id	Task	Status	Note					
▼ Pick_Test_Error_20170919_2.csv								
	Pick Tubes	Done						
	Export	Done						
▼ Details								
Source Sample	Source X	Source Y	Source Rack	Target Rack	Target X	Target Y	Status	Note
0158853981	1	5	UMCN00003893	UMCN00003893	1	5	Done	
0158853937	1	6	UMCN00003893	UMCN00003893	1	6	Done	
0158819522	1	8	UMCN00000617	UMCN00003893	1	3	Error	Error of moving tube
0158856580	1	1	UMCN00003893	UMCN00003893	1	1	Done	
0158817877	1	4	UMCN00003893	UMCN00003893	1	4	Done	

Picture 17: Pick Task Management

By right clicking onto the pick task the context menu is provided. This menu is active in the states created, running and error. The “Retry” and the “Continue” functions are solely used in the error status. Is the error state caused by a hardware error this needs to be resolved in order to continue operating the system. “Retry” would allow to perform a second attempt of moving the sample causing the error. “Continue” does skip the error sample and jumps to the next sample in line. “Cancel” allows to cancel the pick order.

Barcode	Cassette	Level
REMP00274307	309	1
REMP00250841	309	2
REMP00226766	309	3
UMCN00003749	309	4
REMP00250448	309	24
REMP00250572	310	30

Status	Date	User	Note
Created	11:44 09.19.2017	LiconTST	
Waiting	16:35 09.19.2017	ADMIN	
Running	16:35 09.19.2017	ADMIN	
Done	16:36 09.19.2017	LiconTST	

Picture 18: Export Task Detail 2

Selecting the “Export” task of the export job, provides at the details view the list of plates associated with the export job.

Trigger Unload

There are two ways to trigger an unload of a plate from the system through the Import – Export Interface. The first is the most direct and will provide the plate immediately onto the transfer station.

Selecting the export task and right click on one of the racks shown in the details view will provide a context menu. Select the item “Export Rack to Xfer” the plate will be unloaded from the system directly to the transfer station.

Id	Task	Status	Note
▼ Pick_Test_Error_20170919_2.csv			
	Pick Tubes	Done	
	Export	Done	

Barcode	Device	Partition	Cassette	Level
UMCN00003893	Buffer	Buffer	1	2

Picture 19: Unload plate from system

The second possibility requires to select in the context menu the item “Export Rack to Buffer” the plate will be moved into the buffer area inside the interface unit. To remove the rack the door icon in the interface has to be clicked. Follow the dialogues. When the door is closed again the unit will perform an inventory. The plate will be removed from the system if she is not found anymore inside the buffer during the inventory.

16.2.3 Exception Plates

If the system has detected a deviation in the 2D codes read during the scanning step and the content provided at the time of import creation, the plates will be sent to the safe area. In this case the plates will also show up in the Exception Racks section of the Import – Export interface. These racks can be unloaded with a right click for further investigation and correction if needed.

Barcode	Cassette	Level
REMP00274307	309	1
REMP002508	309	2
REMP00226766	309	3
UMCN00003749	309	4
REMP00250448	309	24
REMP00250572	310	30

Picture 20: Exception Racks

The plate is transferred directly to the transfer station if “Export” is selected.

16.2.4 Connections

In the connection menu the connection to the scheduler can be reestablished. Also the “Update content” can manually be triggered. This function is used if an expected entry in the Import or Export view is not present. Update content will recheck in the database if there are new entries not yet visualized.

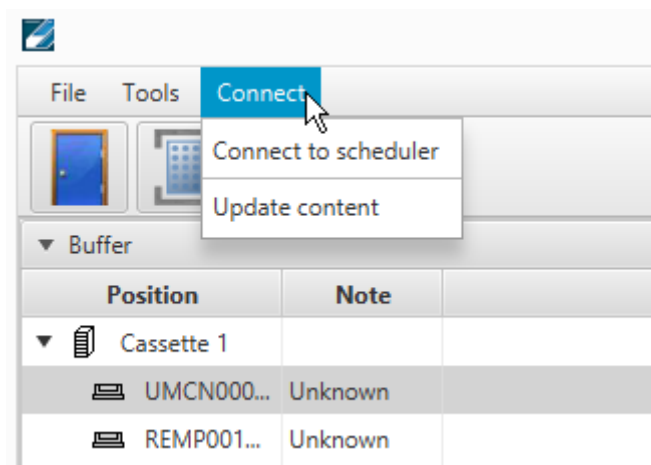

Picture 21: Connection Menu

16.3 PlateExplorer

The PlateExplorer is the more sophisticated administrative access possibility to the Storage system. It allows to manage the system and use some functions manually. The functions accessible may vary according to user permissions. Administrator users have the least restrictions.

The PlateExplorer is a network based application and can run therefore on a remote computer over the network. Before using the application every user has to log on. (Picture 22)

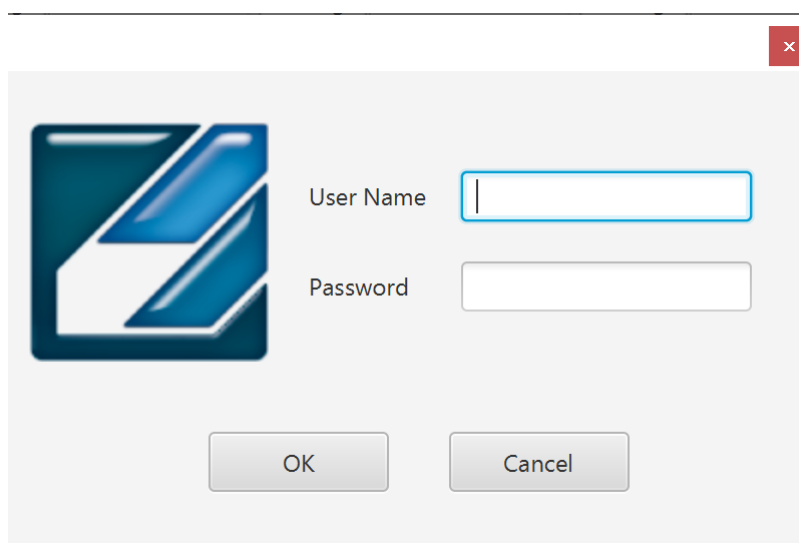

Picture 22: The PlateExplorer's login window

16.3.1 General Functionalities

In this chapter the functionality accessible to the administrator and the normal user are described. There is only one difference between user and administrator. Whilst the user has only access to the assigned area, the administrator has access to the full store. Therefore the difference will not be mentioned in this part of the manual anymore.

Cut&Paste

Cut and paste is used to move manually plates between all the available positions. Some positions do not offer the possibility to paste a plate to as this functionality is limited. Also, tubes may be used with the cut and past functionality but this is only available when plates are present on the tube picker.

To move multiple plates or tubes hold the CTRL button pressed and select the plates to be moved. On the picker the same is possible with tubes, also on the picker a rubber band selection may be used to select multiple tubes.

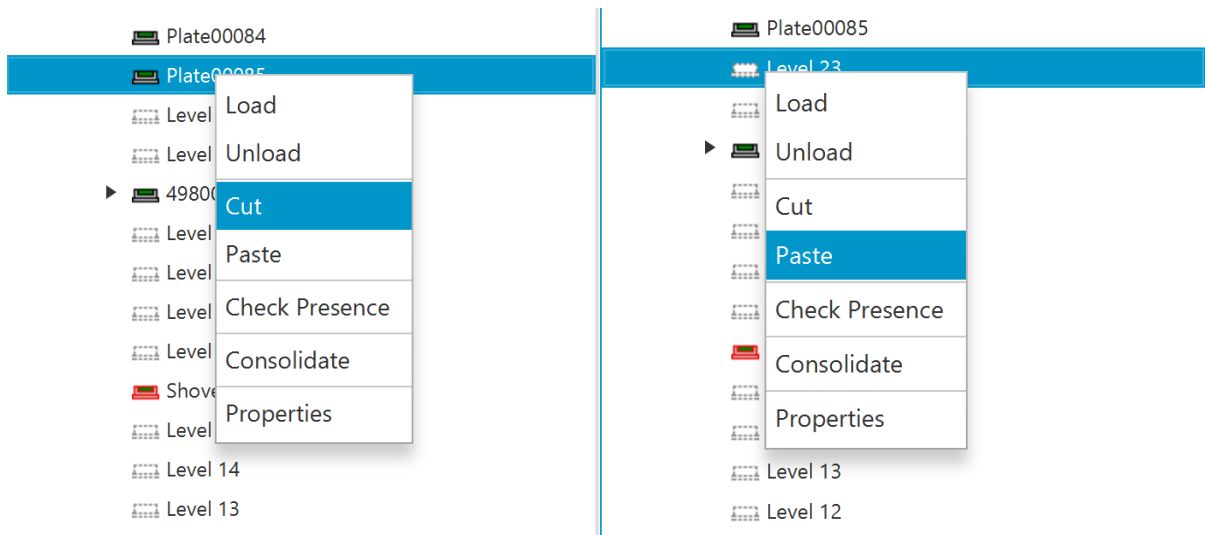

Picture 23: Cut&Paste a plate

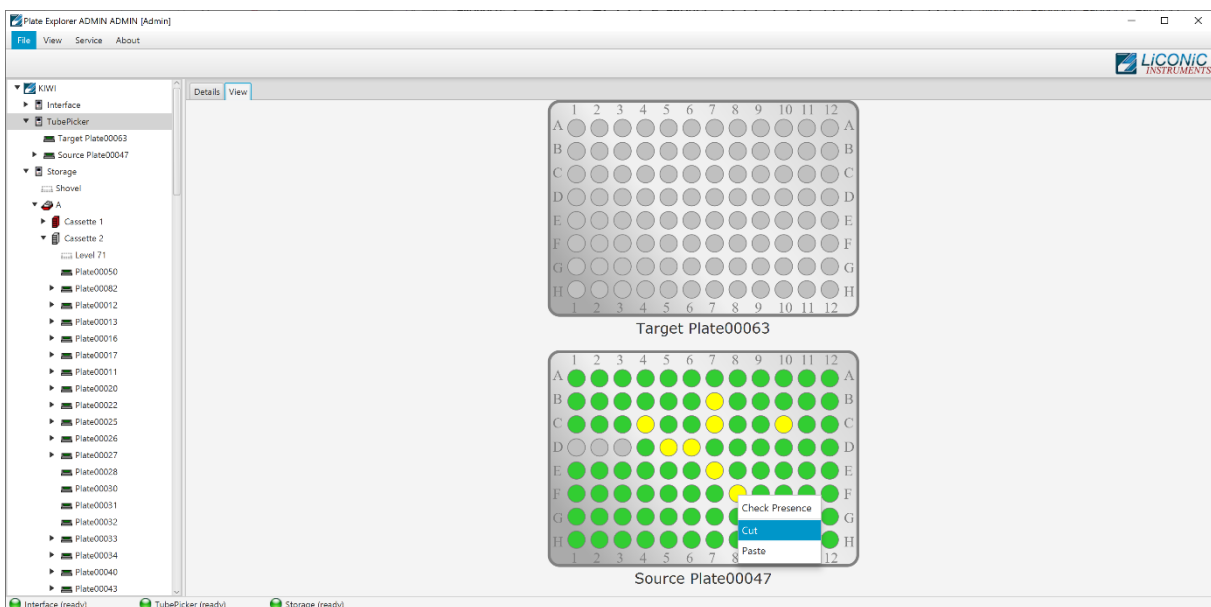

Picture 24: Cut&Paste tubes

16.3.2 Layout of the PlateExplorer

The main window of the PlateExplorer is subdivided into the Menu bar, the contents tree on the left and the detailed information view on the right (see Picture 25).

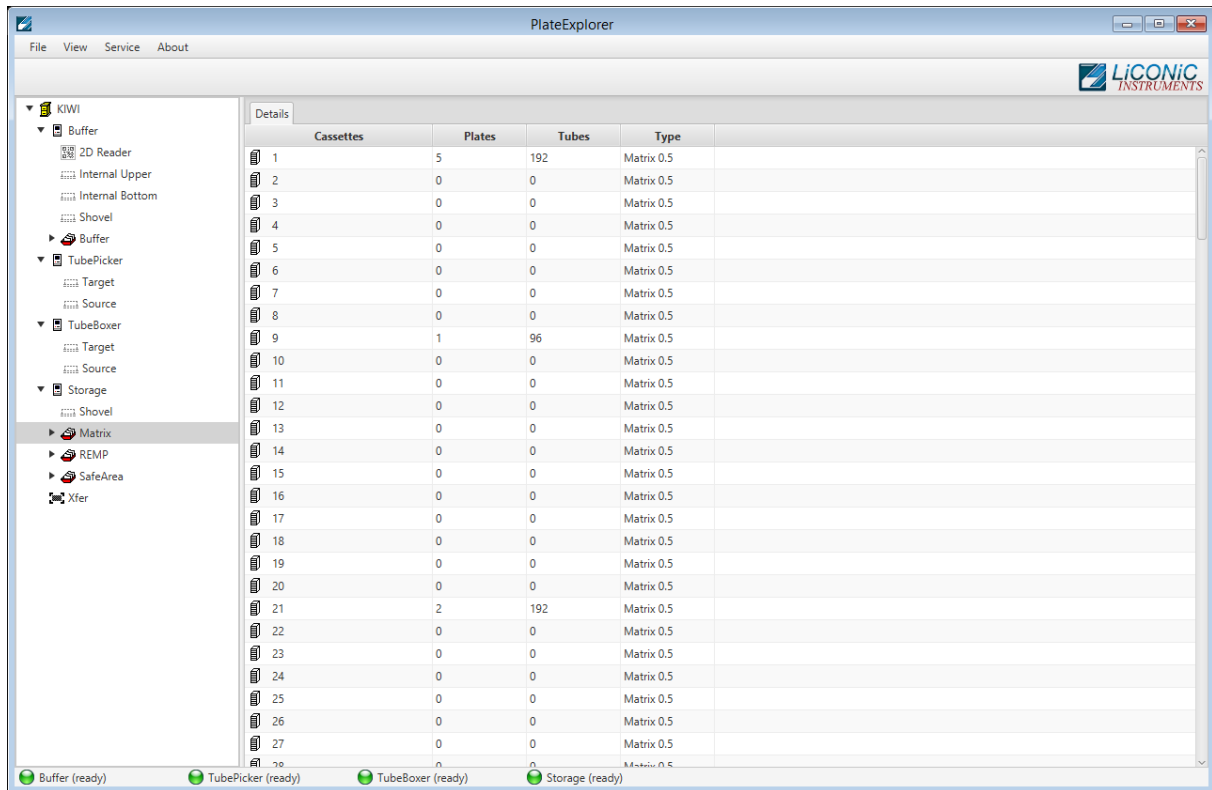

Picture 25: Main screen of the PlateExplorer

The Menu Bar

The menu bar of the PlateExplorer covers four main entries.

The “File”-menu item offers the user to “Exit” the program.

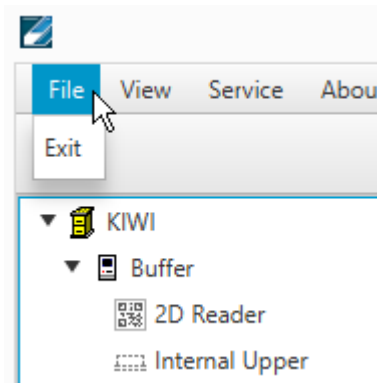

Picture 26: File Menu Entry

The “View” options enable the user to define the way to look at the items being displayed in the PlateExplorer’s Detail View on the right.

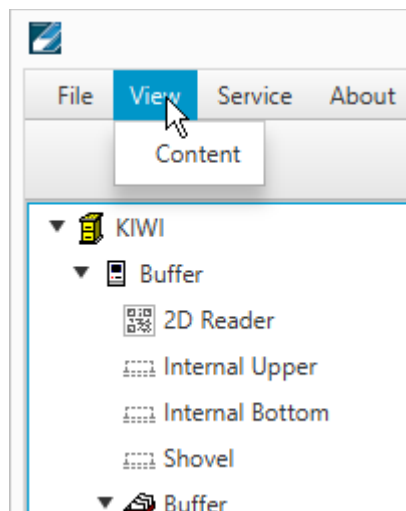

Picture 27: View Menu Entry (to be checked)

The “Service” allows access to the Service functions. Currently it contains only the entry to reestablish the connection to the server.

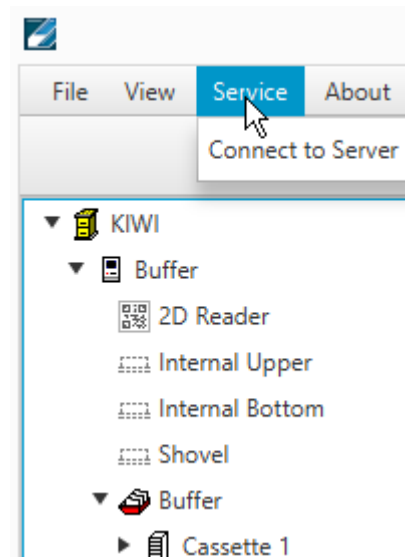

Picture 28: Service Menu Entry (to be checked)



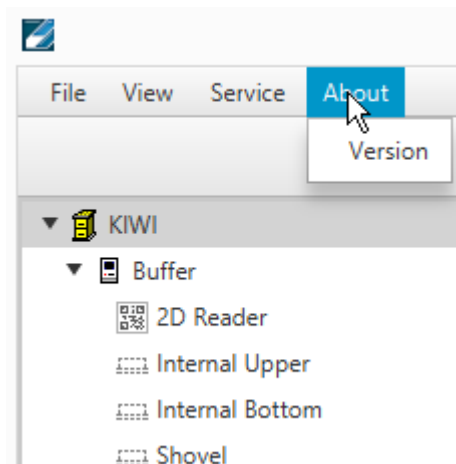

The “About” window will show information on the running PlateExplorer software.



Picture 29: About Menu Entry

Tree View

The tree view is located on the left side of the PlateExplorer window. All accessible positions plates are held are represented in the tree view. Transfer positions such as internal upper and bottom position, 2D Reader, Tube handling source/target and cassette positions can be accessed. Some positions only allow cut from it and not paste to them.

Icon	Meaning
▶  4980000002054	Known Plate type with read barcode (arrow indicates content in plate)
▶  Plate00062	Known Plate type not yet read barcode or not readable barcode
 099/000012	Unknown plate type with read barcode
 Plate 304	Unknown plate type with not yet read barcode or unreadable barcode

Picture 30: Rack symbols in the Tree View

The tree view represents the physical devices and positions present in the system. This may slightly vary depending on the system configuration.

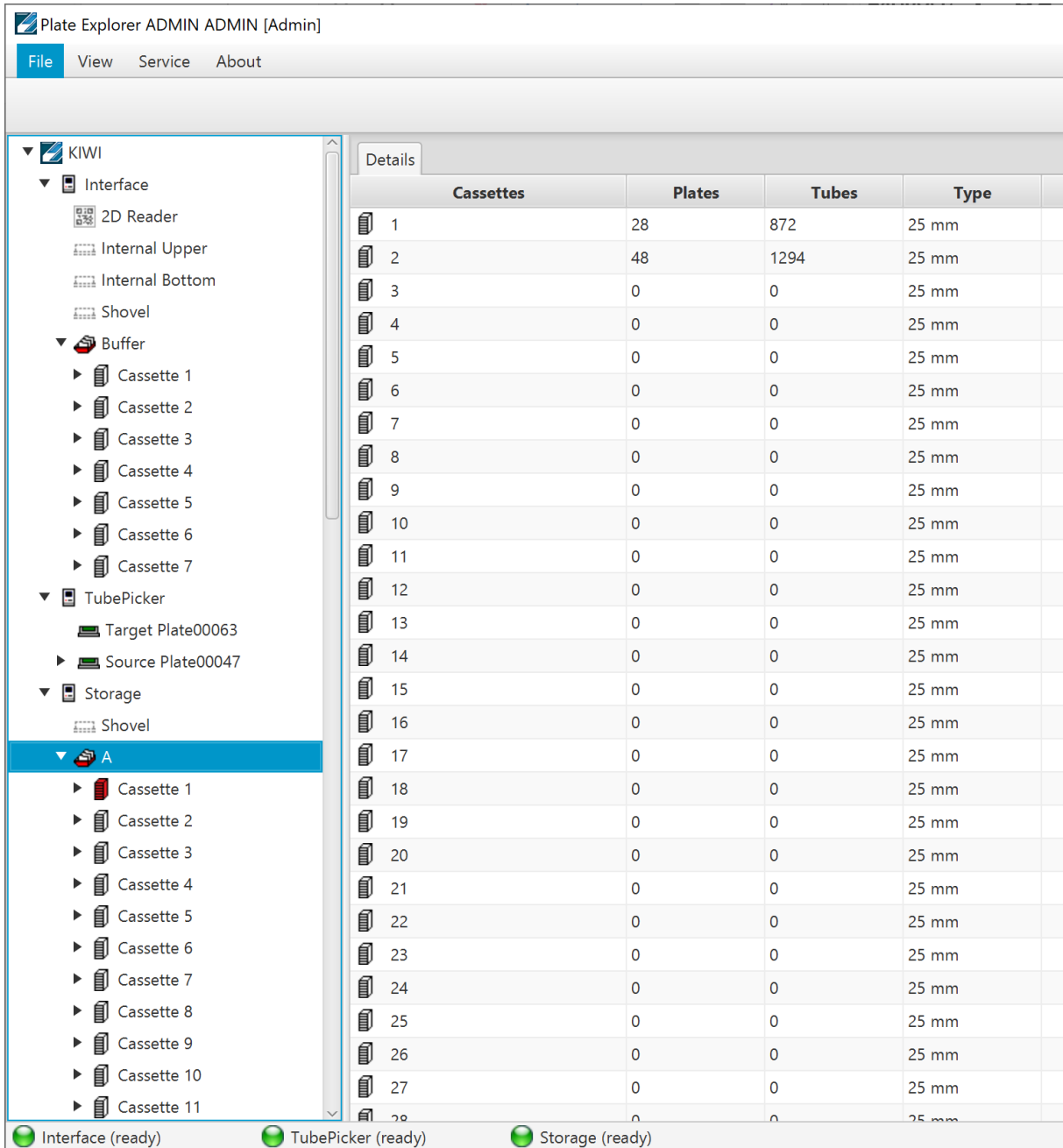

Picture 31: Tree View Overview

The Detail Information Screen

The detail information screen on the right of the PlateExplorer shows the user all properties of the item selected within the tree view on the left. Its functionality can mostly be accessed with the help of the right-click action menus. The Partition management will be described in the corresponding chapter of this manual.

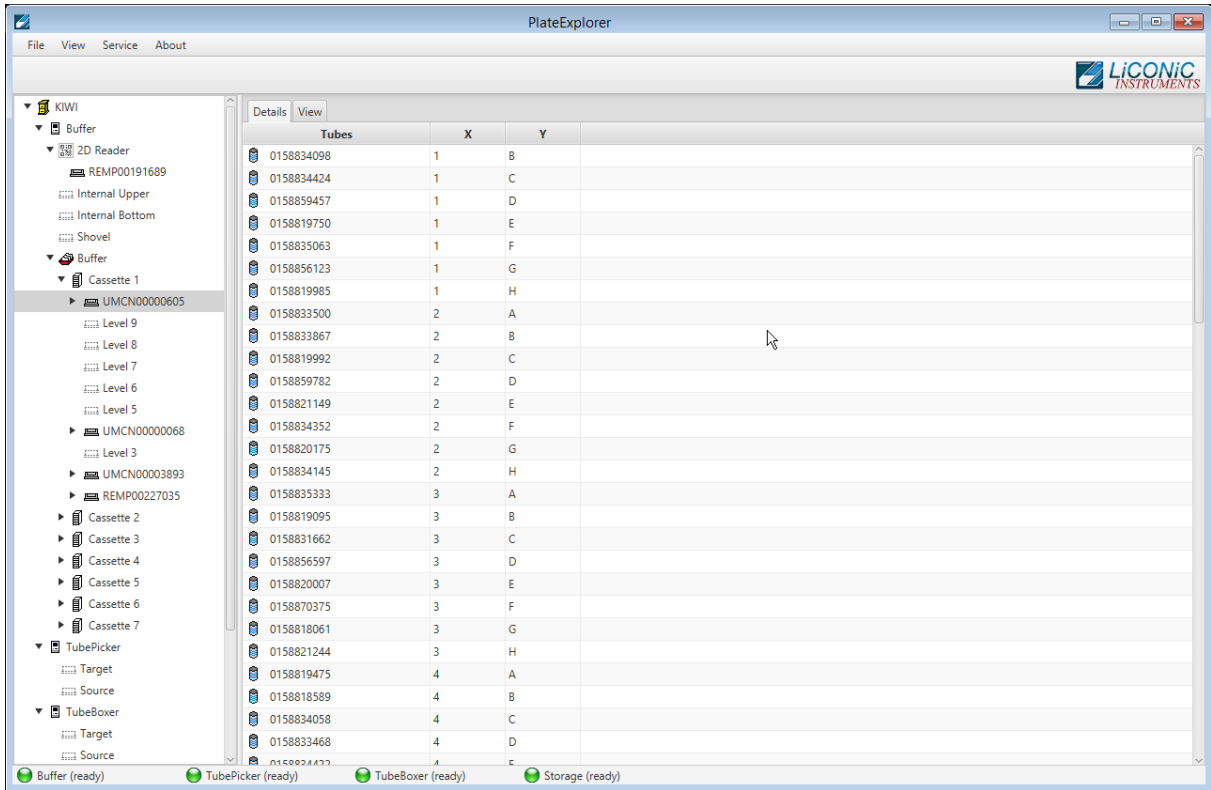

Picture 32: Plate Explorer Detail View

Alternative to the detail view a location view can be selected. It is only available on plate level. A visualization of the plate with its physical positions is presented. The positions are represented as grey if they are empty or as green if a tube is present. A red position with a question mark indicates a tube present with an unreadable 2D code.

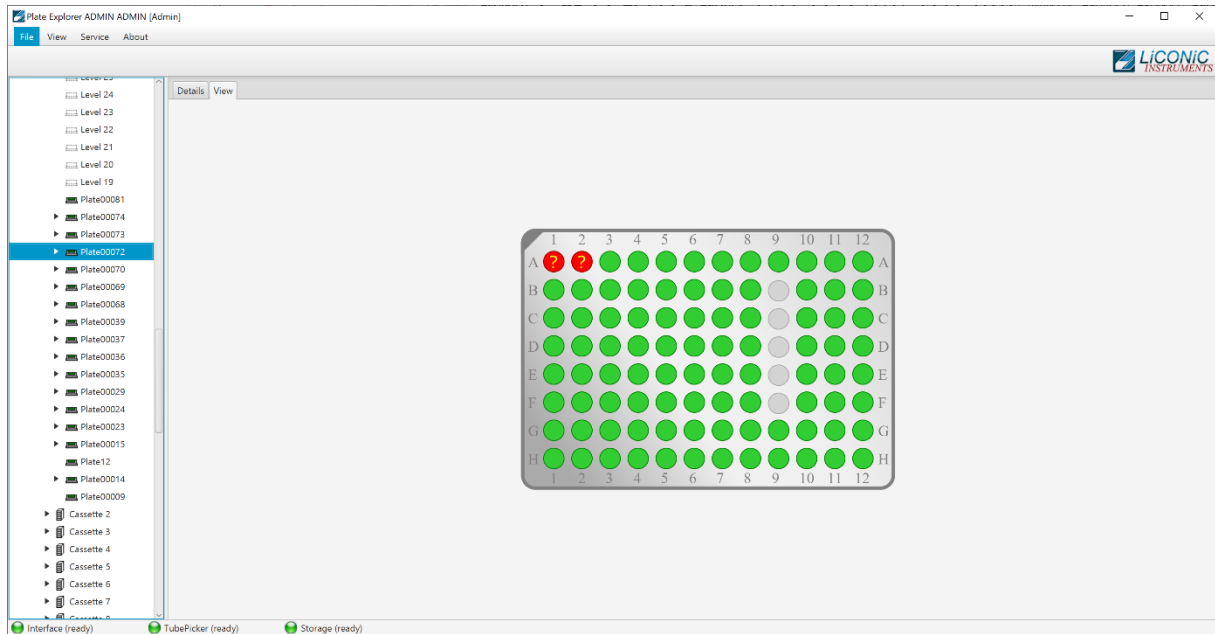

Picture 33: Plate Explorer Location View

16.3.4 Partitions Tool

Depending on the use of the system different partitions can be created. Partitions are virtual subdivisions and can be used to split the storage capacity for different uses, user groups or experiments. To launch the partition tool mark the system unit with a left click, then right click and select “Partition” in the menu. (Picture 36)

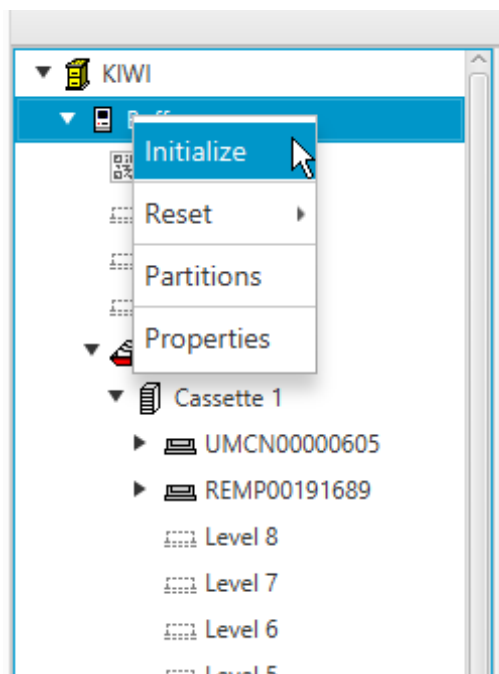

Picture 36: PlateExplorer Right Click Menu

The “Partitions tool” will be started. The tool does allow to “Add”, “Delete”, “Rename” and “Resize” partitions. Not all option may be available all the time as restrictions may disable some of the functions. For example, it is not possible to add further partitions if no unassigned cassettes are present. The function may be accessed through right click either on the graphic bar (Picture 37) or the table (Picture 38).



Picture 37: Right Click Menu Graphic

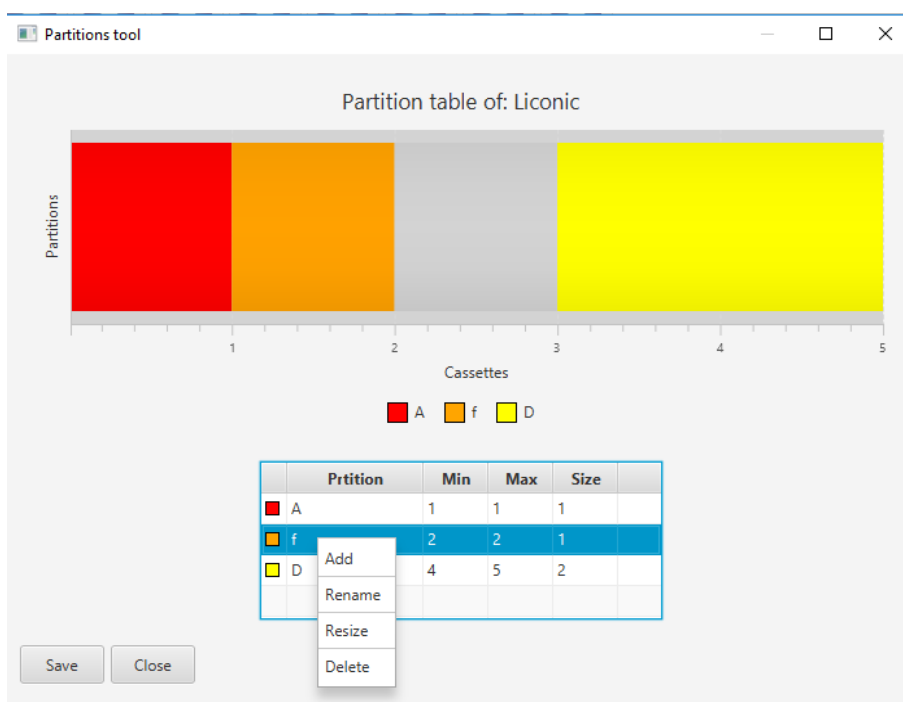

Picture 38: Right Click Menu Table

Existing partitions can easily be manipulated. Just right click into the graphic or the table and select the option. The “Add Partition” in the graphic is only available if unassigned cassettes (represented in grey) are available. (Picture 39)



Picture 39: Add Partition Unassigned Cassette

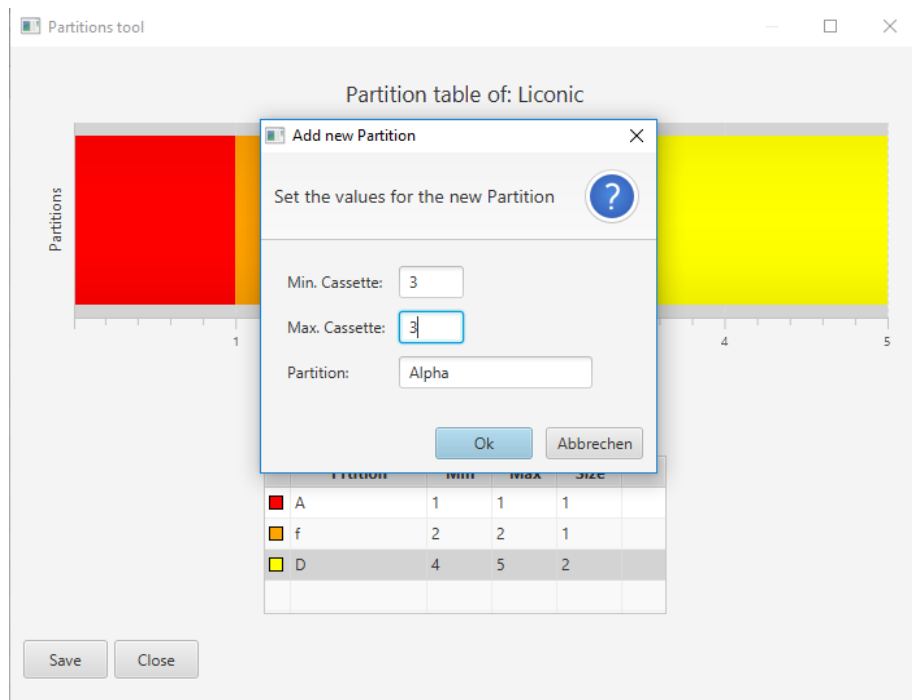

Picture 40: Add Partition Dialogue

Unassigned cassettes can be used to create a new partition (Picture 41) or assign them to an existing partition (Picture 42). Adding cassettes to existing partition will be represented by the same coloring. In the table the cassettes will be displayed in order only the partition name will show their association.

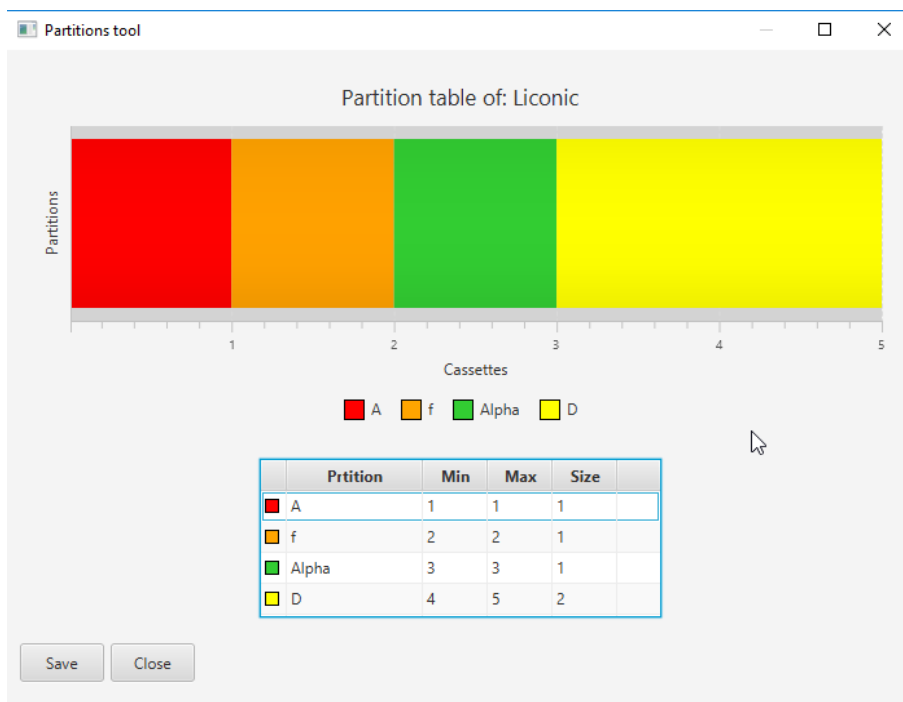

Picture 41: Added New Partition



Picture 42: Added Existing Partition

Already existing partitions can be assigned to another partition by renaming. The obsolete partition will be renamed to the same name as the chosen one and the cassettes will be assigned to this partition.

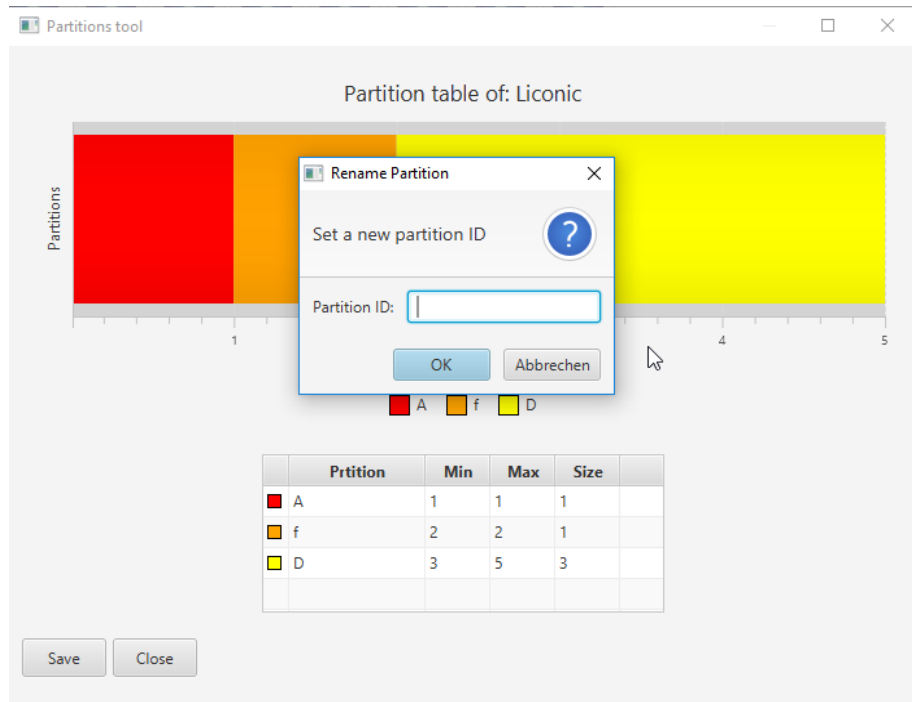

Picture 43: Dialogue Rename

If cassettes are “scattered” meaning a partition consists of cassettes not being next to each other the partition segments have to be deleted individually (Picture 44).



Picture 44: Deleted Partition A

Also partitions may be resized (Picture 45). The partitions may be made larger if unassigned cassettes are available or made smaller if they consist of more than one cassette. Resizing is not available if the minimal partition size of one cassette is present and no unassigned cassettes next to the partition available (Picture 46).

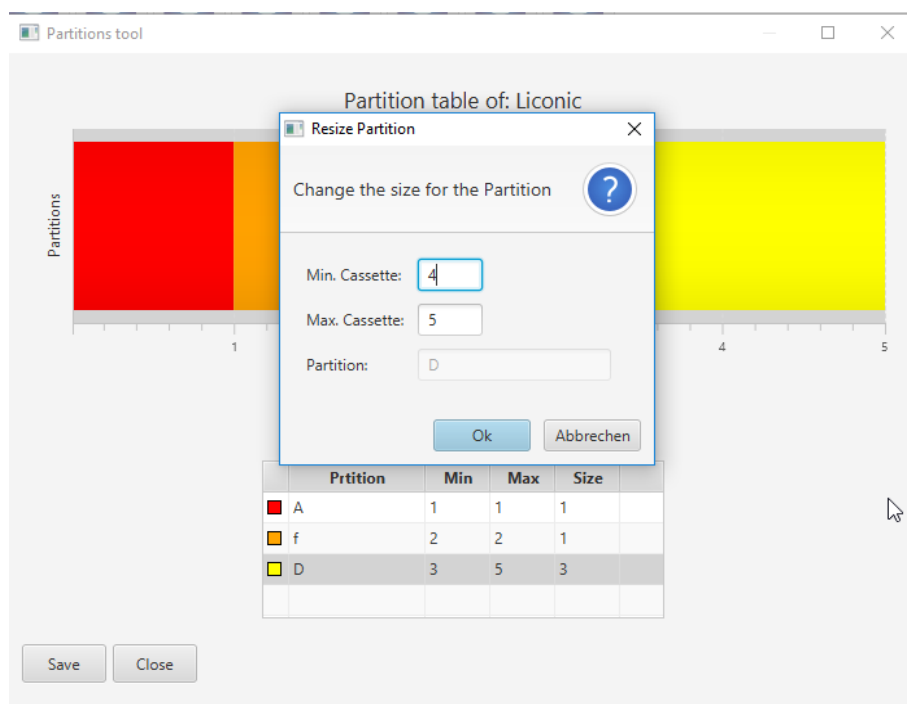

Picture 45: Resize Dialogue



Picture 46: Resize Not Possible

16.3.5 Right-Click Action Menus in the Tree View

The right-click action menus are the most powerful tool within the PlateExplorer. They cover most of the commands and their content is depending on where they get activated.

Right-Click a “Unit”

When right-clicking a unit, a sub menu appears as shown in Picture 47 below.

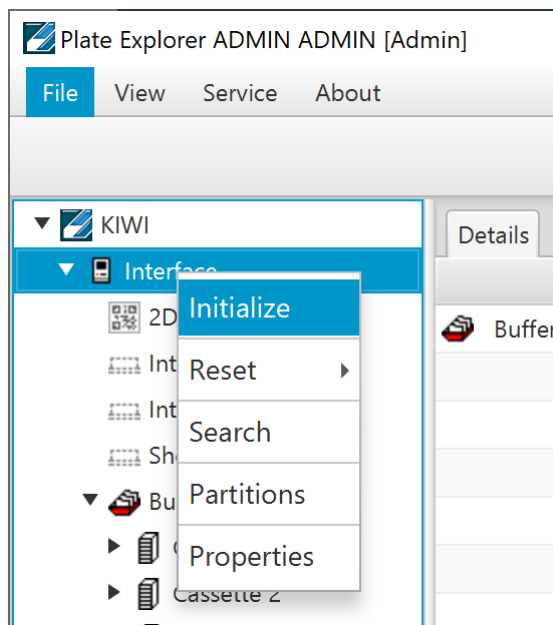

Picture 47: Right Click Menu Unit

“Initialize” the unit will be initialized and all necessary parameters transferred to the unit.

“Reset” the unit will be reset. The Reset entry offers two further options. “Reset” triggers a complete reset of the system requiring to perform an initialization as consequence to use the system again. “Soft Reset” allowing to continue on the exact same position without the need to initialize. The system will by itself cause a complete reset if a soft reset is attempted, when an error of the hardware requires a mandatory reset and initialization procedure.

“Partition” this entry is required to modify the partitions of a unit. The details are described in the chapter 16.3.4.

“Properties” is divided into two tabs. The tab “Properties” shows the hardware settings for the COM-port of the unit, its firmware and its current status. The “Climate” tab by itself is subdivided in to two additional tabs “Temperature” and “Humidity”. In these tabs it is possible to set alarm values for the software to trigger mail alarms in case of exceeding the allowed boundaries. The humidity tab may not be available for all system types.

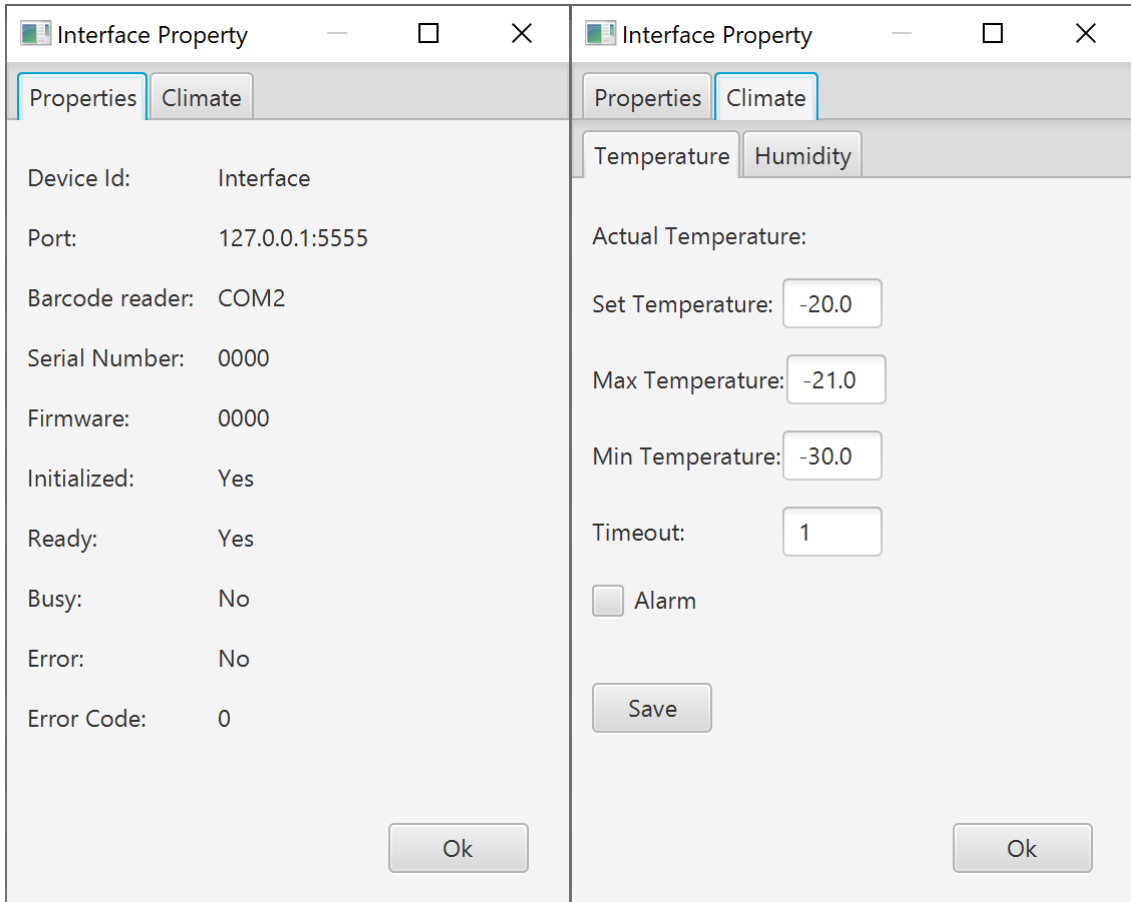

Picture 48: Unit properties

Right-Click a “Partition”

When right-clicking a partition, a sub menu with several options appears.

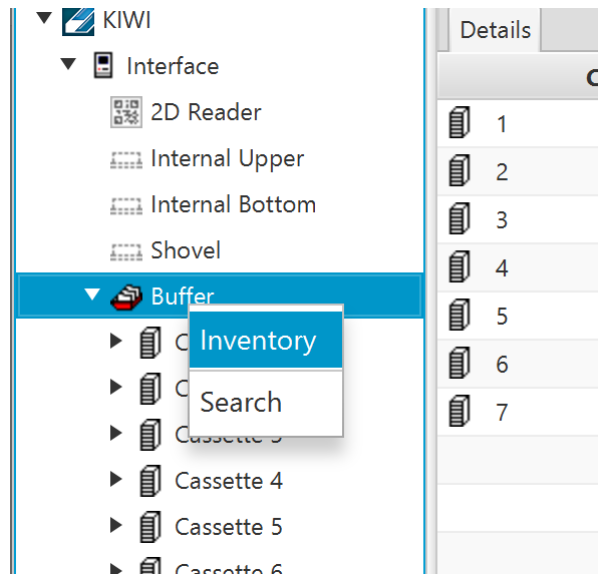

Picture 49: Right Click Menu Partition

“Inventory” starts a 1D barcode inventory on the selected partition.

“Search” lets the user search within the partition for key words such a plate barcode, tube code or fragments of them. Additional search parameters are available.

Right-Click a “Cassette”

When right-clicking a cassette, there are two options to choose from:

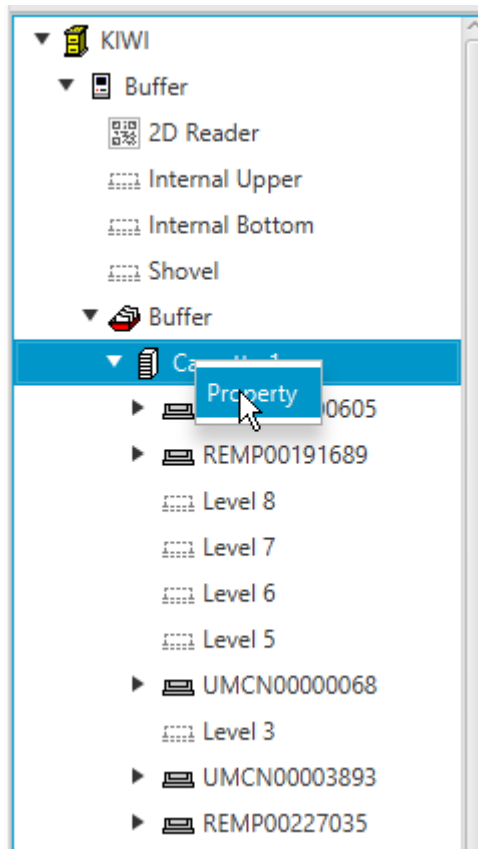

Picture 50: Right Click Menu Cassette

“Properties” will show the usage graph of the clicked cassette and a check box to block the complete cassette for administrative reasons.

Right-Click a “Level”

When right-clicking a level, several options will appear:

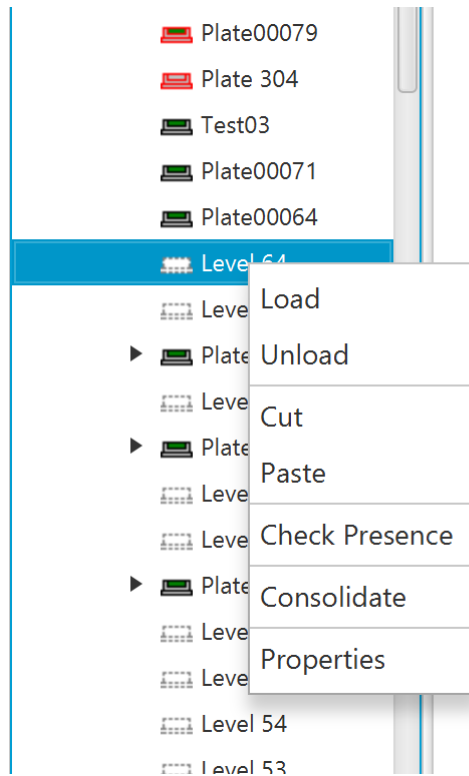

Picture 51: Right Click Menu Level (to be checked)

“Cut” and “Paste” will enable the user to move plates within the system as described in 1.3.1. under “Using Cut&Paste”.

“Load” and “Unload” are direct access commands and will, when activated, immediately load a plate from the transfer station onto this level or unload the existing plate onto the transfer station.

“Check Presence” will check the presence of a rack/plate on that level and if a plate is present read its barcode.

“Consolidate” will trigger a consolidation for all selected plates. Multiple plates can be selected by holding CTRL pressed clicking on them.

The “Properties” of a rack in a level allows under the tab “Plate” to set the PlateID, add some note, see location information of the chosen Level. Furthermore, the plate type can be removed or the plate type changed. Changes of the plate type are only possible with certain limitations. These limitations are depending on the cassette the plate is located in. Changing the plate type to a different one from a previously selected one is not possible.

If a level is clicked without a plate or rack being stored in it, the Properties only show the levels plate history and enable the user to close the level for administrative reasons. A closed level will not be accessed.

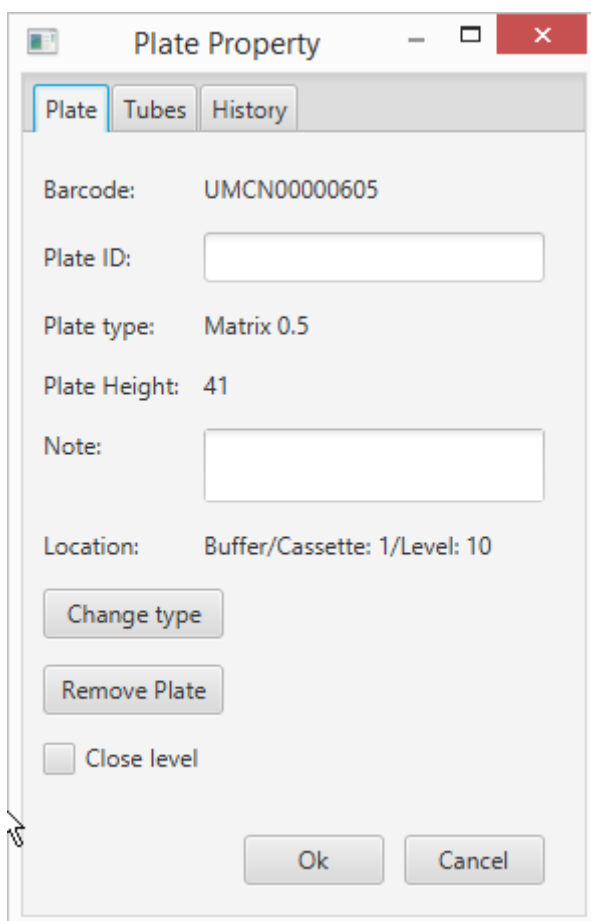

Picture 52: Plate Properties Plate Tab

Under the tab “Tubes” it is possible to set the tube type if not yet set and load content from an XML file. Furthermore, the content of the plate can be saved as a file. Some general information about the tube configuration and the content of the plate is shown such as the tube parameters, number of tubes and free locations.

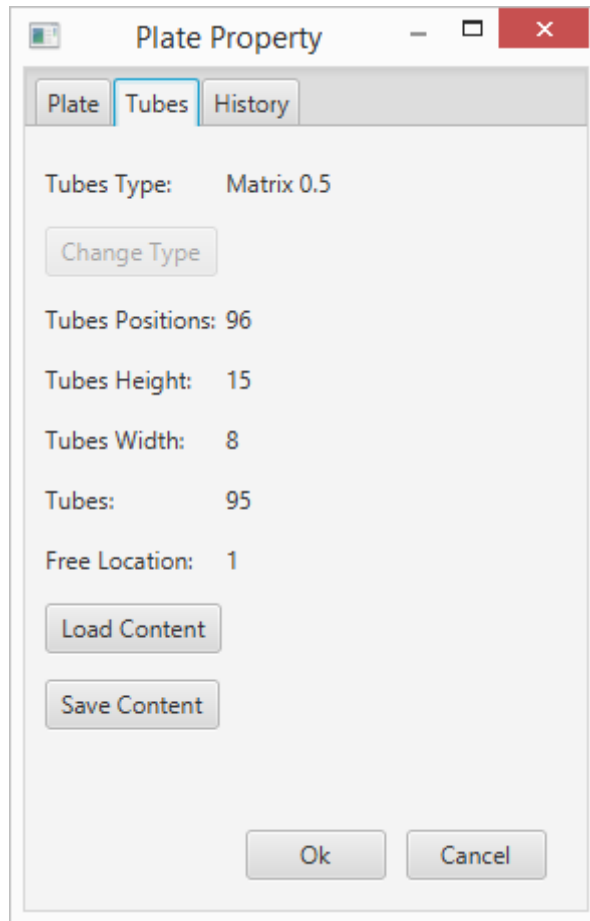

Picture 53: Plate Properties Tubes Tab

The tab “History” and its sub tabs “Level” and “Plate” are explained in the following chapter HISTORY.

16.3.6 History

The “History” tab in the level and plate properties allows to access the history data for the respective. The history contains the information which user did conduct, the respective Event at which date and what Barcode and User ID was involved.

User	Date	Event	Barcode	uid
LiconTST	2017-07-14 12:11:38.657	Load	UMCN00000605	
LiconTST	2017-07-14 12:09:43.967	Unload	UMCN00000605	
LiconTST	2017-07-13 15:36:07.513	Load	UMCN00000605	
LiconTST	2017-07-13 11:48:50.19	Unload	UMCN0000068	
LiconTST	2017-07-10 14:39:52.27	Load	UMCN0000068	
LiconTST	2017-07-10 12:10:03.65	Presence		
LiconTST	2017-07-03 15:12:11.943	Presence		
LiconTST	2017-07-03 14:55:44.537	Unload	REMP00270469	
LiconTST	2017-07-03 14:54:56.71	Load	REMP00270469	
LiconTST	2017-07-03 14:54:17.863	Unload	REMP00270469	
LiconTST	2017-06-27 07:15:41.767	Load	REMP00270469	
LiconTST	2017-06-26 14:13:15.27	Presence		
LiconTST	2017-06-26 08:12:32.47	Presence	UMCN00001329	
LiconTST	2017-06-23 11:08:00.293	Presence	UMCN00001329	
LiconTST	2017-06-23 10:11:36.83	Presence	UMCN00001329	
LiconTST	2017-06-22 15:37:33.13	Presence	UMCN00001329	

Picture 54: Properties History Level

If no plate is present when selecting a level only the history of the respective level is available.

Is a plate present on the selected level, the history of this plate is available. Similar to the level history the User manipulating the plate, the date, the performed Event and the location of the plate are displayed.

User	Date	Event	Device	Cassette	Level
LiconTST	2017-07-14 12:11:38.657	Load	Buffer	1	10
LiconTST	2017-07-14 12:09:43.967	Unload	Buffer	1	10
LiconTST	2017-07-13 15:36:07.513	Load	Buffer	1	10
LiconTST	2017-07-13 15:35:05.763	Unload	Storage	1	15
LiconTST	2017-07-13 15:33:25.607	Load	Storage	1	15
LiconTST	2017-07-13 15:32:36.887	Unload	TubePicker	1	1
LiconTST	2017-07-13 15:31:35.87	Load	TubePicker	1	1
LiconTST	2017-07-13 15:30:42.2	Unload	Storage	1	15
LiconTST	2017-07-13 12:08:32.717	Load	Storage	1	15
LiconTST	2017-07-13 12:07:39.793	Unload	Buffer	1	1
LiconTST	2017-07-13 12:06:48.607	Presence	Buffer	1	1
LiconTST	2017-07-13 12:06:32.293	Load	Buffer	1	1
LiconTST	2017-07-13 11:52:57.817	Unload	Buffer	1	1
LiconTST	2017-07-10 14:37:13.487	Presence	Buffer	1	1
LiconTST	2017-07-10 14:36:10.597	Load	Buffer	1	1
LiconTST	2017-07-10 14:29:18.377	Unload	Buffer	1	2

Picture 55: Properties History Plate

16.3.7 Right-Click Menu on Tubes at Tube Handling

The right-click menu on the tube handling unit covers the following items:

“Cut” and “Paste” enable the user to manually move tubes from plate to plate on the device.

“Check Presence” will work only depending on the model of the tube handling. If integrated, the function checks if a tube exists on the clicked location within the rack. Depending on the system configuration the check presence will automatically trigger a code reading if such a reader is present. This is mostly used to scan an additional side code on tubes.

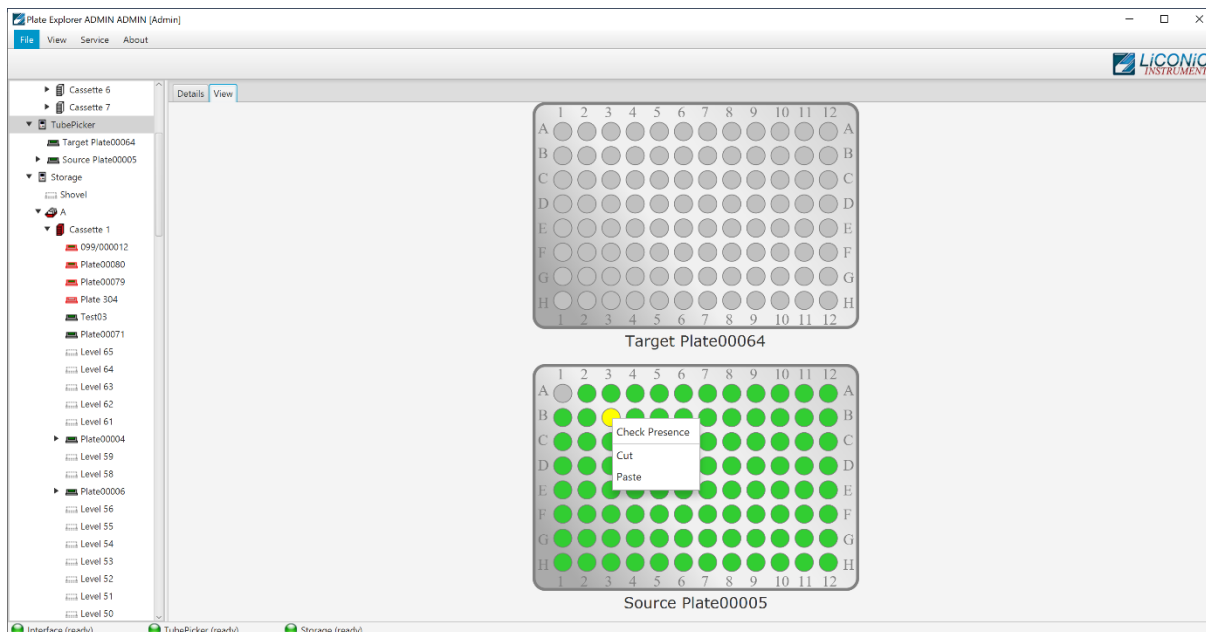

Picture 56: Right-click Menu on Tubes on the Tube Handling

16.3.8 Right-Click Action Menu on 2D Rack Reader

The right-click menu on the 2D Rack Reader allows to select the following items:

“Cut” and “Paste” enable the user to manually move plates and racks from and to the reader. “Check Presence” will check if a plate or rack is present on the reader. “Property” will allow access to the settings of the reader

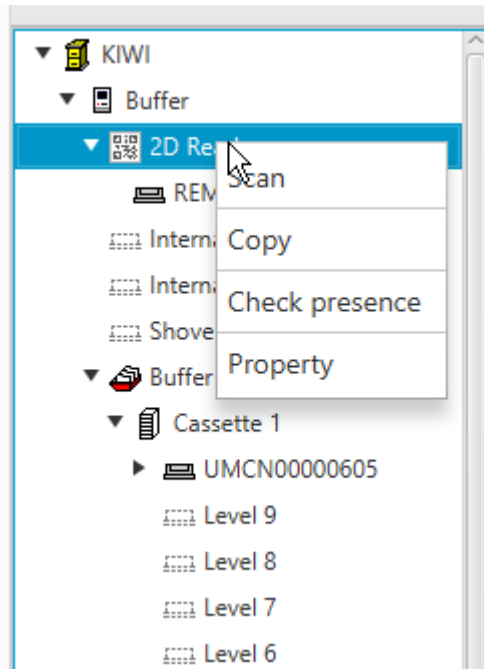

Picture 57: Right Click Menu 2D Rack Reader (to be checked)

Under Properties the configuration of the 2D reader can be done. The scan group for each tube type is set. This has to be done in order to use the correct settings to read the 2D codes for each tube type.

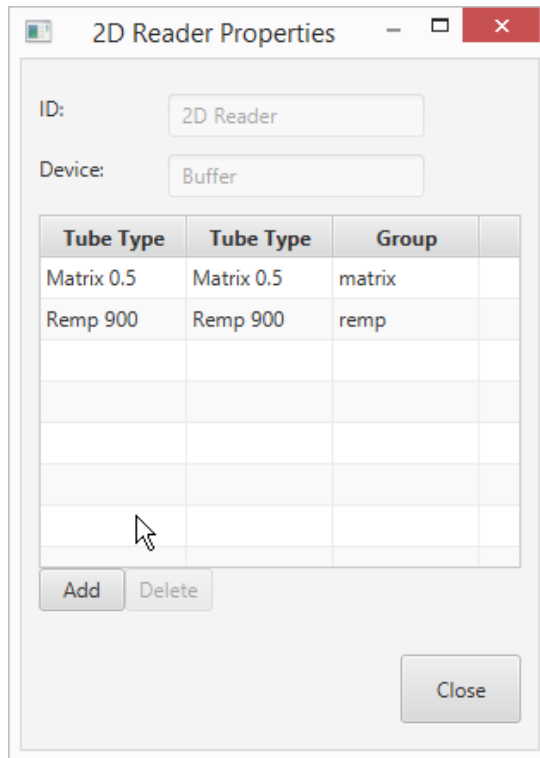

Picture 58: 2D Reader Properties

Selecting the “Scan” option will trigger a scanning process when a plate is present on the scanner. An additional Window is opened showing the result of the scan. This window allows to re-scan or save the scan results into the database. It has two display options one shows the locations of the tubes in a visual representation and the other one as a list.

The readable tubes are represented with blue marking, not tube is represented by a grey location. Tubes which have been detected as present but the 2D code has not been readable are represented by red with a question mark.

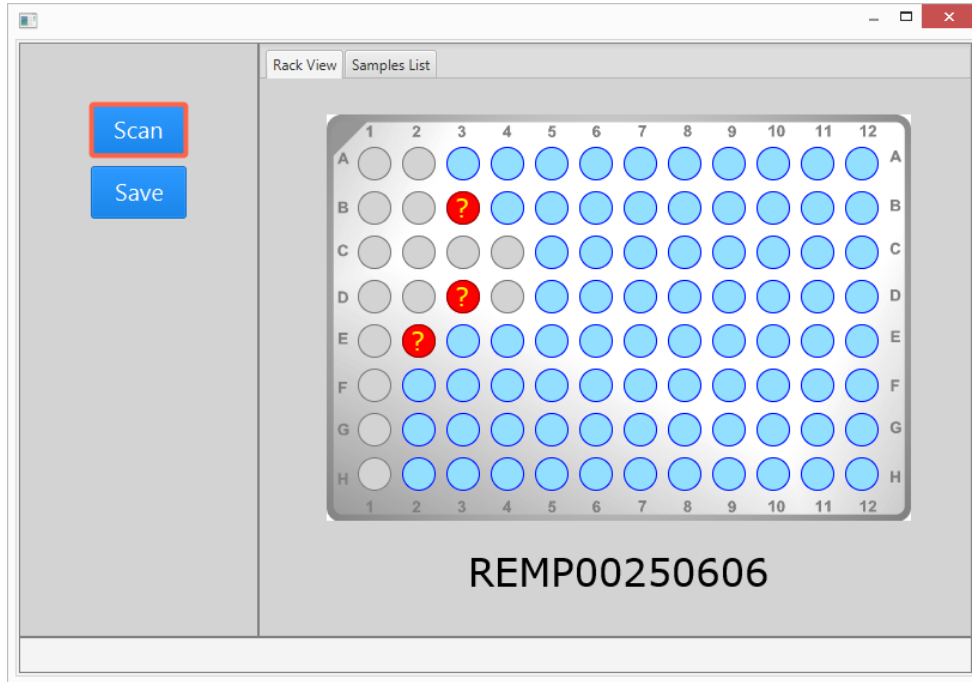

Picture 59: Scan Result Location View

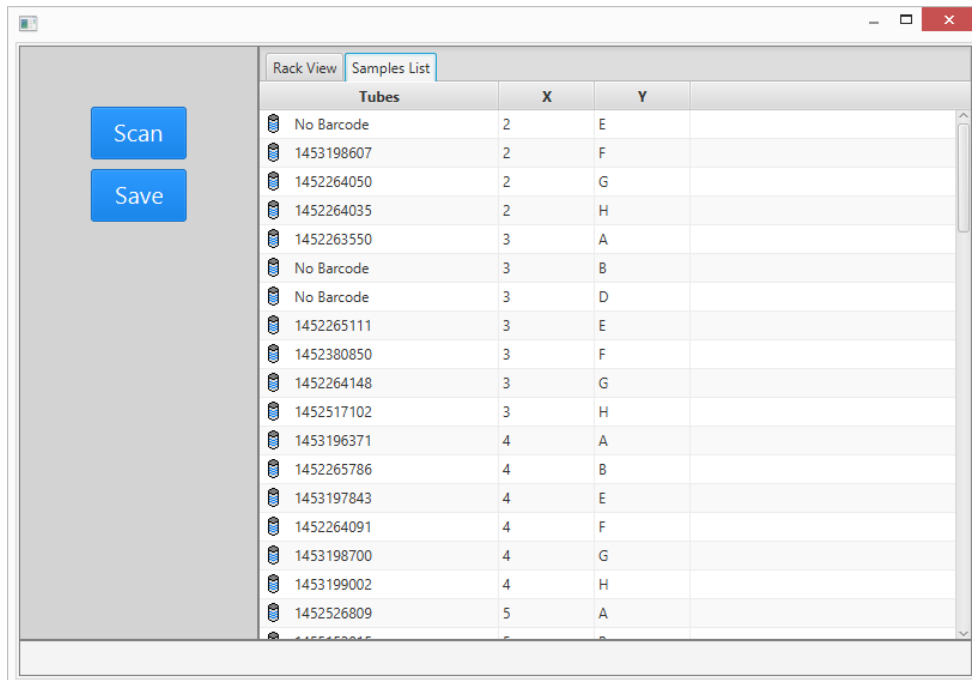

Picture 60: Scan Result List View

16.4 Job Manager

The JobManager Web based interface allows to manipulate jobs. The different coloring of the jobs are indicating their status and manipulation can be performed upon them such as Cancel, Continue, Retry, Delete.

The available functions are provided by each job/task. If a job/task is in error it will offer the options Continue, Retry and Cancel if they are possible. Every job/task can be canceled. Deletion of a job/task is only possible if the status is canceled. This means in order to delete a job/task it has to be canceled first.

To access the JobManager user interface, it is required to log in. The access to this may be restricted, depending on the user access rights

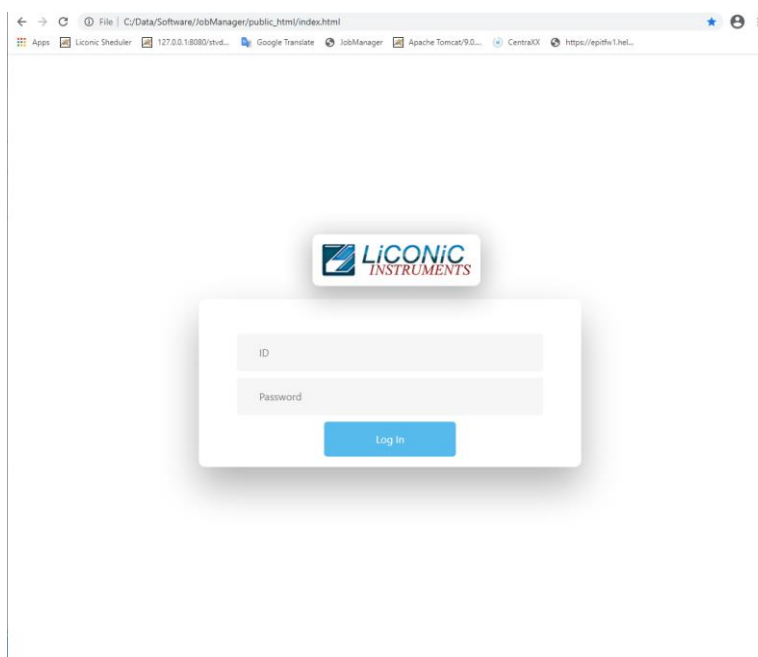

Picture 61: JobManager Log In Page

16.4.1 Use of JobManager

The JobManager offers the possibility to manage jobs within the job queue of the system. The jobs may show different states and allow different manipulation depending on their state. The following states can be present:

- Running: Currently running job
- Pending: Job in queue ready for running
- Finishes: Job in the process to reach done state
- Unknown: Jobs with an unknown state
- Cancelled: Jobs which have been cancelled
- Error: Job in Error status due to logical or hardware error

For a better visualization the different states are represented with different colors.

ID	Type	User	UID	Tasks
135974	Job File	ADMIN		1
136019	Job File	ADMIN		2
136021	Import	ADMIN		1
136022	Import	ADMIN		1
136023	Import	ADMIN		1
136024	Import	ADMIN		1
136025	Import	ADMIN		1
136026	Import	ADMIN		1
136027	Import	ADMIN		1
136048	Job File	ADMIN		2
8838	Import	ADMIN		2
15	Import	ADMIN	5.7_BMP1	1
17	Export	ADMIN	export1_TEST0024	1
15557	Import	ADMIN	export1_TEST0024	1

Picture 62: JobManager Main Page

Jobs in the different states allow for different manipulations. To delete a job from the queue it has to be first cancelled. The cancelation of a job can be easily performed by pressing the “X” within the circle at the right of each job. Only after the cancelation the delete icon in the shape of a trash bin becomes available.

Jobs and task in error present the possible manipulation option when right clicking on to the job or task. There are three different options available to be selected:

- **Retry:** The system attempts the same step again
- **Continue:** The system jumps to the next step in the process
- **Cancel:** The job is canceled

Retry:

The retry option allows to attempt the same operation again at the time of error. The system has to be left in the same state as the error appeared, only clearing the error condition. The system will then try to do the exact same step again in the process and continues the operation afterwards. This option would be selected per example if a tube was not possible to be taken out of a source rack, the tube is still present at the origin position and the condition why the tube was not possible to be moved has been rectified.

Continue:

The continue option allows to jump over the error step and continue the job with the next step in the process. For this the error step needs to be cleared and the system put back in operational state. This option may be selected if for example a tube has been missing and can not be transferred. In this case the step can not be retried and the system needs to continue with the next step.

Cancel:

The cancel option can be selected if a job or task can not be retried not continued or if the retry/continue is not within the interest of the user. This may be the case if a general issue is detected or it has been decided to abandon the job and continue with another task.

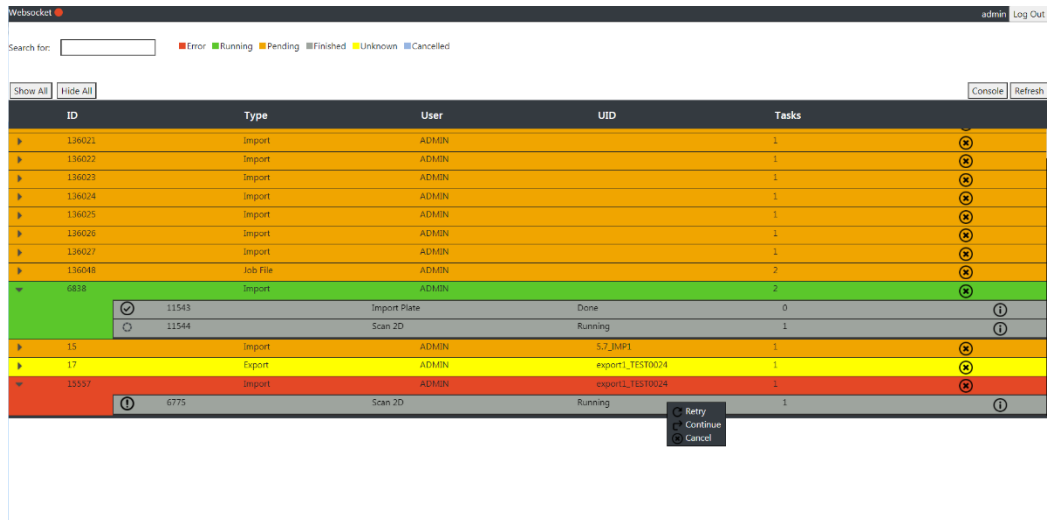

Picture 63: JobManager Task Options

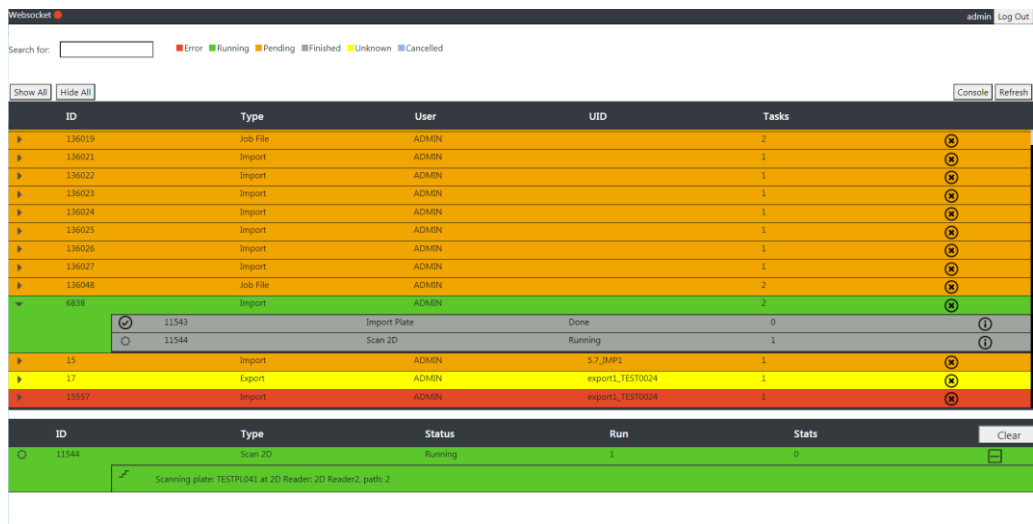

Picture 64: JobManager Task Details

16.5 Climate Reporting

The climate reporting interface is used to extract climate data from the database. The historic and current climate values can be accessed, displayed and saved for further use.

To access the Climate Reporting user interface, it is required to log in. The access to this may be restricted, depending on the user access rights

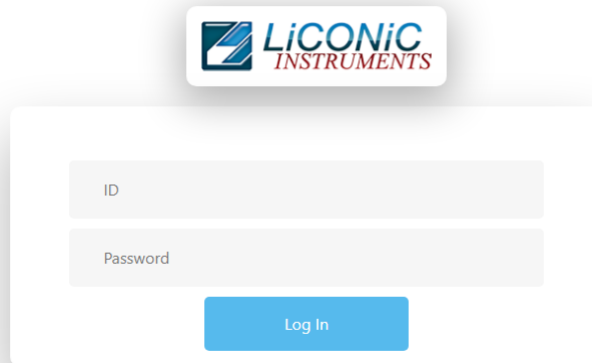

The image shows a login form for the Climate Reporting interface. At the top center is the LiCONiC INSTRUMENTS logo. Below the logo is a white rectangular box containing two input fields: 'ID' and 'Password'. Below these fields is a blue button labeled 'Log In'.

Picture 65: Climate Reporting Log In

The main page after the log in will show an overview of all device which have temperature recording. The current climate data are shown

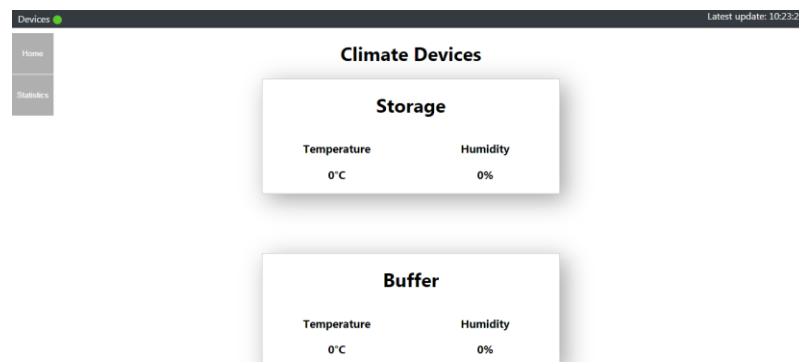

Picture 66: Climate Reporting Main Page

To access the detail view for a device, the device is selected and clicked. Afterward a graph view is presented.

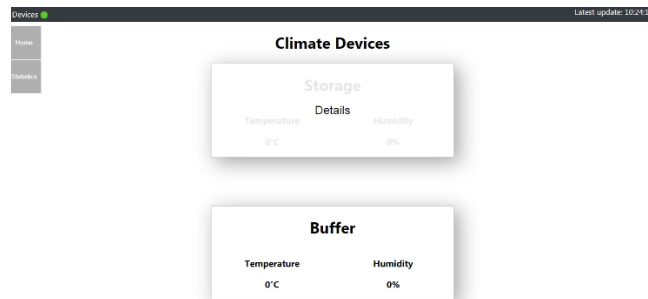

Picture 67: Climate Reporting Device Selection

The graph view allows to view current and historic data. The displayed data can be selected by device. It is offered either to display data from a historic point until now or to a specific date.

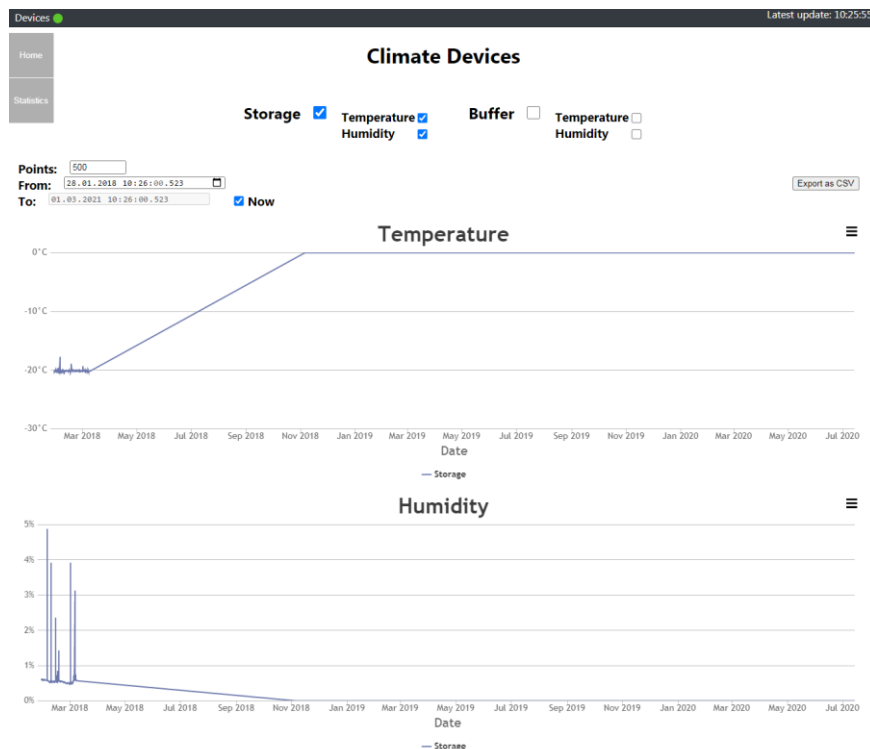

Picture 68: Climate Reporting Graph View

From the graph view it is possible to extract the climate data. The graphs can be saved as picture or directly printed. The climate data can also be exported as a CSV file for further use.

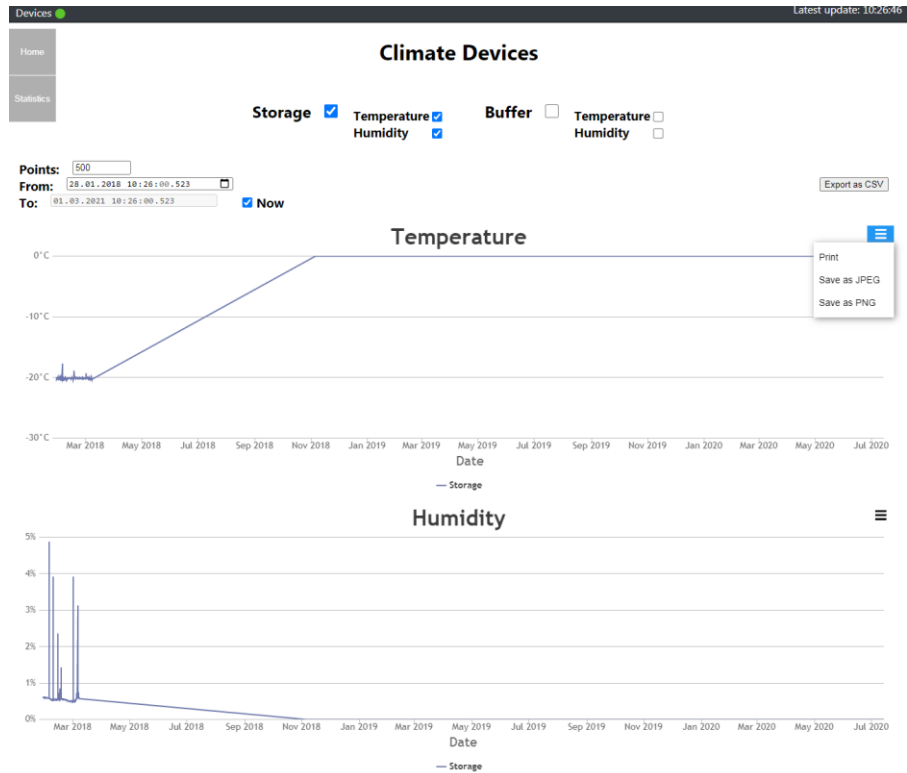

Picture 69: Climate Reporting Save

17. Utility Tools

17.1 Web Terminal

The web terminal can be accessed via any standard web browser. It allows for communication directly to the individual devices. The use of this terminal is for trained only for trained personnel.



CAUTION!

Terminal should only be used by personnel trained in the use of direct commands or under supervision of a Liconic engineer.

The terminal can be used to read out state variables of the system and send direct commands to the hardware. It may be used to change temporarily settings or recover the system from a state which requires intervention on this level. This terminal should only be used by trained personnel or under the supervision of a Liconic engineer. If there are any uncertainty in the use of the terminal please contact your local engineer or the Liconic service organization.

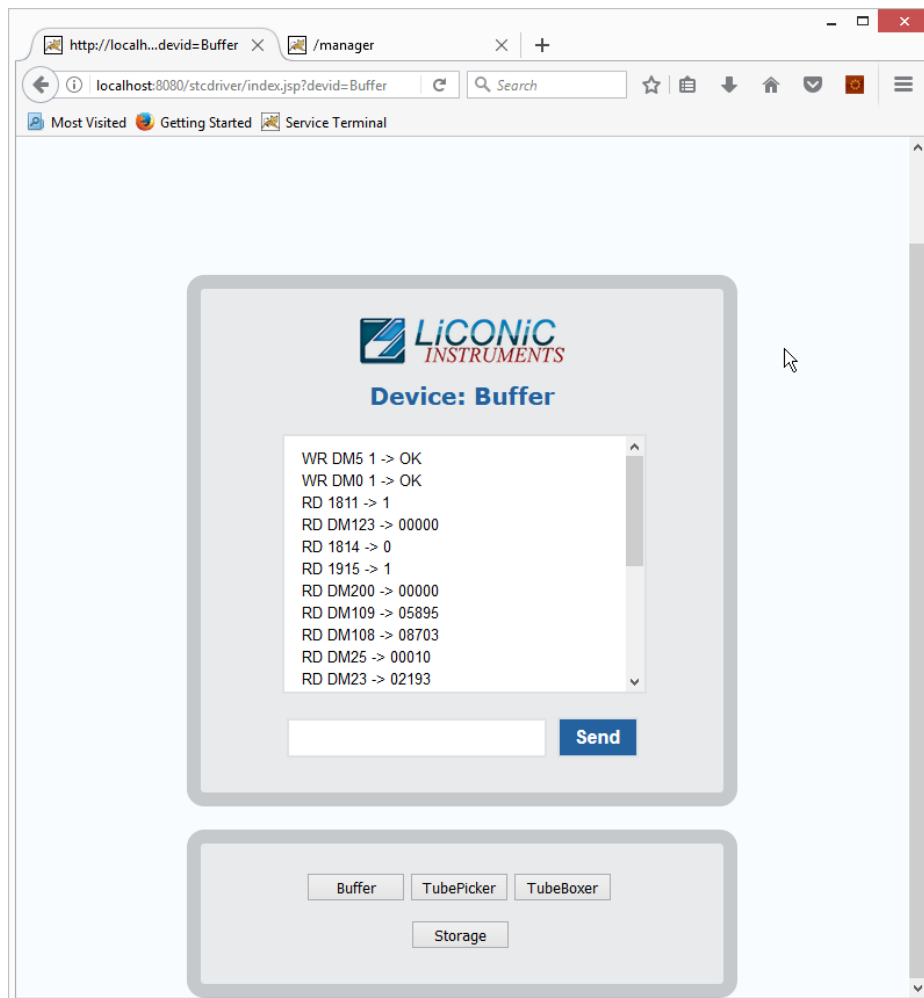

Picture 70: Web Based Commands Terminal

Technical Data

18. Technical Data

18.1 Mechanics

- Cassettes System Configuration Dependant
- Levels Depending on used lab ware
- Position drives Stepper Motor, bipolar, micro-stepping mode
- Shovel drive DC-Motor
- Noise <82dBA / 1m
- RAL Color 9010

18.2 Electronics

18.2.1 Robotics

- Mains 110 / 230VAC, 50/60Hz
- Power consumption Handling Maximum: 1 kW,
Typical: 400 – 600 W

18.2.2 Cooling

- Mains 400 / 380VAC, 50/60Hz
- Power consumption cooling Maximum: 6 kW,
Typical: 3 kW

18.2.3 Communication

- Handling communication Communication via RS-232
2=Controller RX, 3=Controller TX, 5=GND
7,8 and 4,6 shortened
- Barcode Communication Communication via RS-232
Straight connected serial extension
- Software Interface RESTful with XML command structure

18.3 Pneumatics

- Optional Gas Pressure <4 bar

18.4 Water

- Water consumption 3-5 l/min
- Pressure Difference 2.5 bar (max 10 bar Inlet)
- Water Temperature Inlet maximum: 14°C
Outlet regulated: 35°C

18.5 Cooling

Depending on the ordered configuration the cooling may work air or water cooled or a combination of both. Water cooling is recommended for the main cooling. The heat transfer out of the room/building is more efficient than through utilization of air. Air is a good addition for an optional backup cooling.

18.5.1 DF

- | | |
|-----------------------|--|
| • Principle | Single stage compressor, water cooled |
| • Working conditions | Typical: 22°C; ~45% rH
max. Temperature: 26°C |
| • Type of refrigerant | R410a |
| • Refrigerant charge | 1.5 kg |

18.5.2 ULT

- | | |
|-----------------------|--|
| • Principle | Dual stage compressor, water cooled |
| • Working conditions | Typical: 22°C; ~45% rH
max. Temperature: 26°C |
| • Type of refrigerant | R410a/R508a |
| • Refrigerant charge | 1.5 kg/1.5kg |

For detailed installation requirements refer to the section installation.

18.6 Overall Dimensions

System dimensions do depend on the configuration. Dimension for specific systems may be retrieved from LiCONiC according to the needs and room constraints.

18.7 Weights

System weights do depend on the configuration. Weights for specific systems may be retrieved from LiCONiC according to the needs and room constraints.

18.8 Ambient Ratings

Operating:	Temperature:	22 °C
	Relative humidity:	45% or below (non- condensing)
Storage:	Temperature:	10 – 40°C
	Relative humidity:	50% or below (non- condensing)